

# Y

## Y-SUB Manual 1.1 en

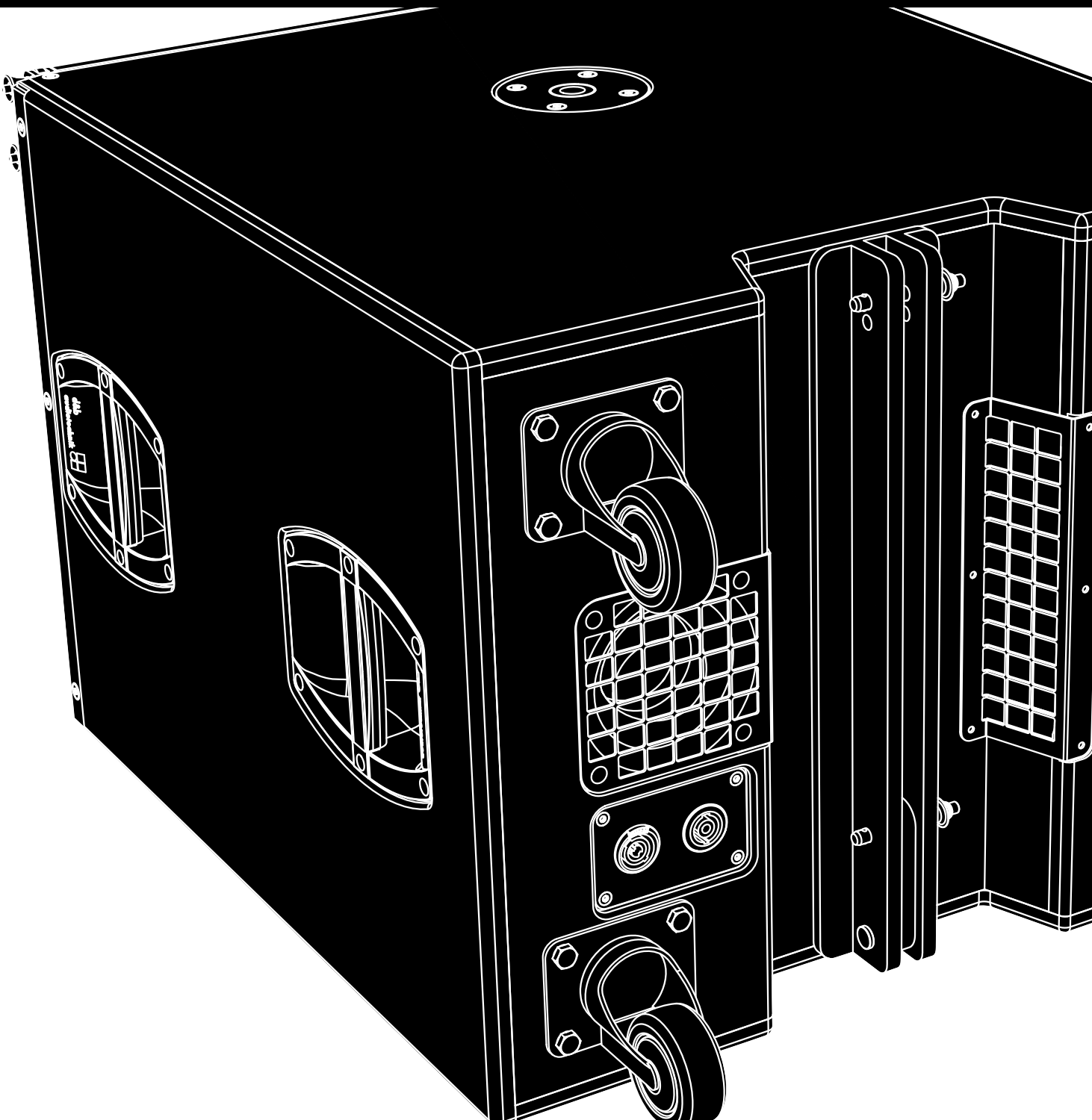

## **General information**

Y-SUB Manual

Version: 1.1 en, 08/2014, D2714.EN .01

Copyright © 2014 by d&b audiotechnik GmbH; all rights reserved.

**Keep this manual with the product or in a safe place so that it is available for future reference.**

When reselling this product, hand over this manual to the new customer.

If you supply d&b products, please draw the attention of your customers to this manual. Enclose the relevant manuals with the systems. If you require additional manuals for this purpose, you can order them from d&b.

d&b audiotechnik GmbH  
Eugen-Adolff-Strasse 134, D-71522 Backnang, Germany  
T +49-7191-9669-0, F +49-7191-95 00 00  
docadmin@dbaudio.com, www.dbaudio.com

<b>1. Safety precautions.....</b>	<b>4</b>
1.1. Information regarding the use of loudspeakers.....	4
<b>2. Y-SUB loudspeaker.....</b>	<b>5</b>
2.1. Product description.....	5
2.2. Connections.....	6
2.3. Operation.....	6
2.3.1. Controller settings.....	7
2.4. Technical specifications.....	7
<b>3. Manufacturer's declarations.....</b>	<b>8</b>
3.1. EU conformity of loudspeakers (CE symbol).....	8
3.1.1. WEEE Declaration (Disposal).....	8

## 1.1. Information regarding the use of loudspeakers

### Potential risk of personal injury

Never stand in the immediate vicinity of loudspeakers driven at a high level. Professional loudspeaker systems are capable of causing a sound pressure level detrimental to human health. Seemingly non-critical sound levels (from approx. 95 dB SPL) can cause hearing damage if people are exposed to it over a long period.

In order to prevent accidents when deploying loudspeakers on the ground or when flown, please take note of the following:

- When setting up the loudspeakers or loudspeaker stands, make sure they are standing on a firm surface. If you place several systems on top of one another, use straps to secure them against movement.
- Only use accessories which have been tested and approved by d&b for assembly and mobile deployment. Pay attention to the correct application and maximum load capacity of the accessories as detailed in our specific "Mounting instructions" or in our "Flying system and Rigging manuals".
- Ensure that all additional hardware, fixings and fasteners used for installation or mobile deployment are of an appropriate size and load safety factor. Pay attention to the manufacturers' instructions and to the relevant safety guidelines.
- Regularly check the loudspeaker housings and accessories for visible signs of wear and tear, and replace them when necessary.
- Regularly check all load bearing bolts in the mounting devices.

### Potential risk of material damage

Loudspeakers produce a static magnetic field even if they are not connected or are not in use. Therefore make sure when erecting and transporting loudspeakers that they are nowhere near equipment and objects which may be impaired or damaged by an external magnetic field. Generally speaking, a distance of 0.5 m (1.5 ft) from magnetic data carriers (floppy disks, audio and video tapes, bank cards, etc.) is sufficient; a distance of more than 1 m (3 ft) may be necessary with computer and video monitors.

## 2. Y-SUB loudspeaker

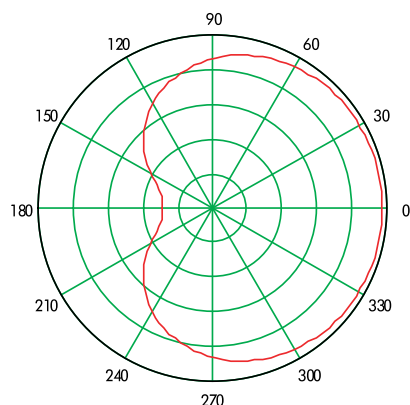
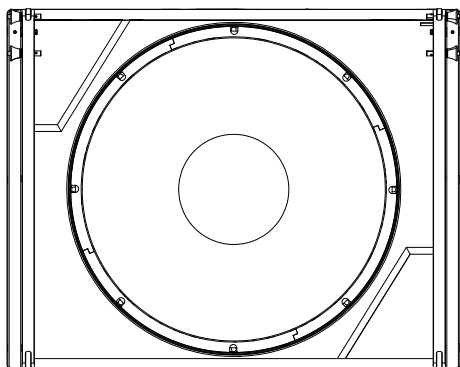

Cardioid dispersion pattern

### 2.1. Product description

The Y-SUB is a compact high performance cardioid subwoofer designed to supplement the d&b Y-Series cabinets.

The Y-SUB houses two long excursion neodymium drivers in an integrated cardioid setup: an 18" driver in a bass-reflex design facing to the front and a 12" driver in a two chamber bandpass design radiating to the rear. The arrangement and tuning provide a cardioid dispersion pattern using a single amplifier channel.

The frequency response extends from 39 Hz to 140/110 Hz.

The cabinet is constructed from marine plywood and has an impact and weather protected PCP (Polyurea Cabinet Protection) finish. The front of the loudspeaker cabinet is protected by a rigid metal grill backed by an acoustically transparent foam. Each side panel incorporates two handles and mounted on the rear panel are four heavy duty wheels. An M20 threaded flange in the top panel accepts a loudspeaker stand or the Z5396 Y Base plate for the deployment of TOP cabinets.

### Cardioid dispersion

Cardioid dispersion avoids unwanted energy behind the system and greatly reduces the excitation of the reverberant field at low frequencies providing the greatest accuracy of low frequency reproduction. The subwoofers can be used as stand-alone solutions or in stacked combinations with a minimum distance of 60 cm (2 ft) between adjacent cabinets or between the subwoofers and a side wall. When positioned in front of walls, the minimum distance to rear walls is maintained by the wheels mounted at the rear of the cabinet.

### Y-Series rigging components and arrays

Cabinets are mechanically connected using the rigging strands on both sides of the cabinet front and a central strand at the rear of the cabinet. All necessary rigging components are mounted to the cabinet and fold out or slide out when needed. The rigging components are also intended to interconnect and secure Y-SUB cabinets in ground stacked applications.

A detailed description of the Y-Series rigging components is given in the Y-Series Rigging manual which is provided with the Y Flying frame.

A detailed description of planning and designing Y arrays is given in the technical information "TI 385 d&b Line array design, ArrayCalc" which is also provided with the Y Flying frame.

The d&b ArrayCalc simulation software can be downloaded from the d&b website at [www.dbaudio.com](http://www.dbaudio.com).

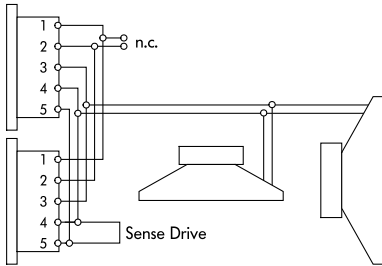
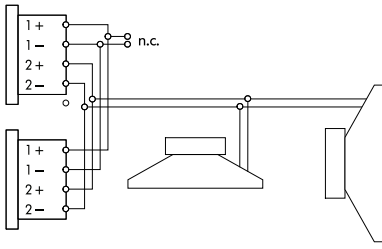

**NLT4 F/M/NL4 and EP5 connector wiring**

## 2.2. Connections

The cabinet is fitted with a pair of NLT4 F/M connectors. All four pins of both connectors are wired in parallel. The Y-SUB uses the pin assignments 2+/2-. Pins 1+/1- are designated to the Y8 or Y12 loudspeakers. Using the male connector as the input, the female connector allows for direct connection to a second cabinet.

The cabinet can be supplied with NL4 or EP5 connectors as an option.

Pin equivalents of the connector options are listed in the table below.

NLT4 F/M NL4	1+	1-	2+	2-	n.a.
EP5	1	2	3	4	5 (SenseDrive front)

### d&b SenseDrive

The SenseDrive feature within D12 amplifiers enables electrical compensation for the properties of the loudspeaker cable used. SenseDrive requires an additional sense wire. SenseDrive is therefore only available with EP5 connectors and 5-wire cabling for applicable loudspeakers.

**Note:** When the D12 is operated in "Mix TOP/SUB mode", the SenseDrive function is available on the output B connector only.

### d&b LoadMatch

Starting with the D80 amplifier, the LoadMatch function enables the amplifier to electrically compensate for the properties of the loudspeaker cable used without the need for an additional sense wire. For applicable loudspeakers, LoadMatch is therefore independent of the connector type used.

## 2.3. Operation

### NOTICE!

Only operate d&b loudspeakers with a correctly configured d&b amplifier, otherwise there is a risk of damaging the loudspeaker components.

Application	Setup	Cabinets per channel
Y-SUB	Y-SUB	2

Within applicable amplifiers, the controller setup is available in Dual Channel or Mix TOP/SUB mode.

### 2.3.1. Controller settings

For acoustic adjustment the 100 Hz function can be selected.

### 100 Hz circuit

If the 100 Hz circuit is selected, the upper operating frequency of the system is reduced from 140 Hz to 110 Hz.

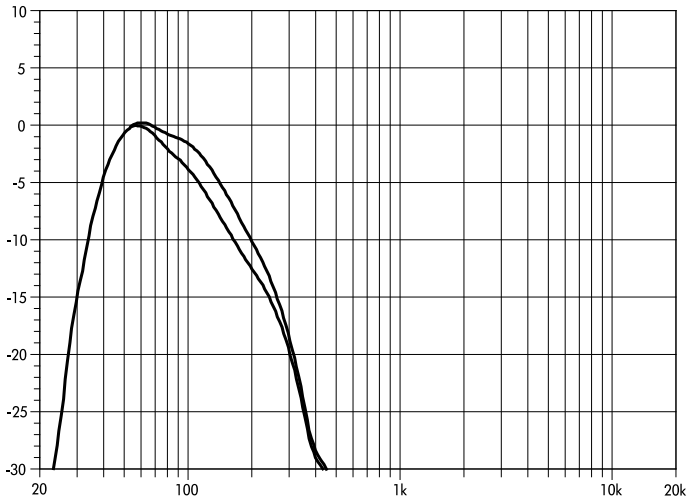

Y-SUB frequency response, standard and 100 Hz mode

### 2.4. Technical specifications

#### Y-SUB system data

Frequency response (-5 dB standard) .....	39 Hz - 140 Hz
Frequency response (-5 dB 100 Hz mode) .....	39 Hz - 110 Hz
Max. sound pressure (1 m, free field) .....	.....
with D80/D12/D6 .....	134 dB/131 dB/128 dB
..... (SPLmax peak, pink noise test signal with crest factor of 4)	.....

#### Y-SUB loudspeaker

Nominal impedance .....	8 ohms
Power handling capacity (RMS/peak 10 ms) .....	600/2400 W
Components .....	1 x 18" driver
.....	1 x 12" driver
Connections .....	2 x NLT4 F/M
.....	optional 2 x NL4 or EP5
Pin assignment .....	NLT4 F/M and NL4: 2+ / 2-
.....	EP5: 3: + / 4: -
Weight .....	52 kg (115 lb)

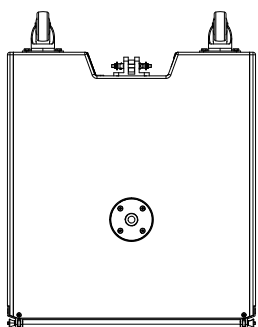
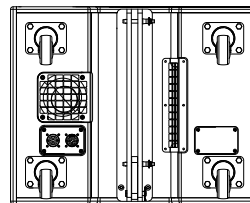
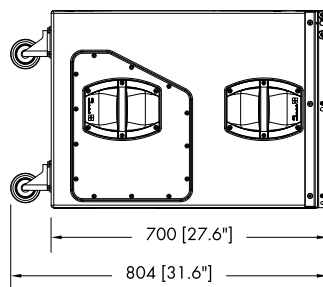
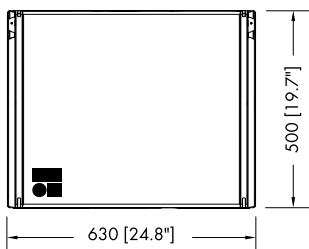

Y-SUB cabinet dimensions in mm [inch]



### 3.1. EU conformity of loudspeakers (CE symbol)

This declaration applies to:

#### **d&b Y-SUB loudspeaker, Z0709**

manufactured by d&b audiotechnik GmbH.

All production versions of these types are included, provided they correspond to the original technical version and have not been subject to any later design or electromechanical modifications.

We herewith declare that said products are in conformity with the provisions of the respective EC directives including all applicable amendments.

A detailed declaration is available on request and can be ordered from d&b or downloaded from the d&b website at [www.dbaudio.com](http://www.dbaudio.com).

#### **3.1.1. WEEE Declaration (Disposal)**

Electrical and electronic equipment must be disposed of separately from normal waste at the end of its operational lifetime.

Please dispose of this product according to the respective national regulations or contractual agreements. If there are any further questions concerning the disposal of this product, please contact d&b audiotechnik.





