

Pioneer

DJ MIXER

DJM-800

Operating Instructions

Thank you for buying this Pioneer product.

Please read through these operating instructions so you will know how to operate your model properly. After you have finished reading the instructions, put them away in a safe place for future reference.

In some countries or regions, the shape of the power plug and power outlet may sometimes differ from that shown in the explanatory drawings. However the method of connecting and operating the unit is the same.

K015 En

IMPORTANT



The lightning flash with arrowhead symbol, within an equilateral triangle, is intended to alert the user to the presence of uninsulated "dangerous voltage" within the product's enclosure that may be of sufficient magnitude to constitute a risk of electric shock to persons.

CAUTION

**RISK OF ELECTRIC SHOCK
DO NOT OPEN**

CAUTION:
TO PREVENT THE RISK OF ELECTRIC SHOCK, DO NOT REMOVE COVER (OR BACK). NO USER-SERVICEABLE PARTS INSIDE. REFER SERVICING TO QUALIFIED SERVICE PERSONNEL.



The exclamation point within an equilateral triangle is intended to alert the user to the presence of important operating and maintenance (servicing) instructions in the literature accompanying the appliance.

D1-4-2-3_En-A

WARNING

This equipment is not waterproof. To prevent a fire or shock hazard, do not place any container filled with liquid near this equipment (such as a vase or flower pot) or expose it to dripping, splashing, rain or moisture.

D3-4-2-1-3_A_En

IMPORTANT NOTICE – THE SERIAL NUMBER FOR THIS EQUIPMENT IS LOCATED ON THE BOTTOM. PLEASE WRITE THIS SERIAL NUMBER ON YOUR ENCLOSED WARRANTY CARD AND KEEP IN A SECURE AREA. THIS IS FOR YOUR SECURITY.

D1-4-2-6-1_En

NOTE: THE NO USER-SERVICEABLE PARTS COMPARTMENT WARNING IS LOCATED ON THE APPLIANCE BOTTOM.

IMPORTANT SAFETY INSTRUCTIONS

- 1) Read these instructions.
- 2) Keep these instructions.
- 3) Heed all warnings.
- 4) Follow all instructions.
- 5) Do not use this apparatus near water.
- 6) Clean only with dry cloth.
- 7) Do not block any ventilation openings. Install in accordance with the manufacturer's instructions.
- 8) Do not install near any heat sources such as radiators, heat registers, stoves, or other apparatus (including amplifiers) that produce heat.
- 9) Do not defeat the safety purpose of the polarized or grounding-type plug. A polarized plug has two blades with one wider than the other. A grounding type plug has two blades and a third grounding prong. The wide blade or the third prong are provided for your safety. If the provided plug does not fit into your outlet, consult an electrician for replacement of the obsolete outlet.
- 10) Protect the power cord from being walked on or pinched particularly at plugs, convenience receptacles, and the point where they exit from the apparatus.
- 11) Only use attachments/accessories specified by the manufacturer.
- 12) Use only with the cart, stand, tripod, bracket, or table specified by the manufacturer, or sold with the apparatus. When a cart is used, use caution when moving the cart/apparatus combination to avoid injury from tip-over.
- 13) Unplug this apparatus during lightning storms or when unused for long periods of time.
- 14) Refer all servicing to qualified service personnel. Servicing is required when the apparatus has been damaged in any way, such as power-supply cord or plug is damaged, liquid has been spilled or objects have fallen into the apparatus, the apparatus has been exposed to rain or moisture, does not operate normally, or has been dropped.



P1-4-2-2_En

NOTE: This equipment has been tested and found to comply with the limits for a Class B digital device, pursuant to Part 15 of the FCC Rules. These limits are designed to provide reasonable protection against harmful interference in a residential installation. This equipment generates, uses, and can radiate radio frequency energy and, if not installed and used in accordance with the instructions, may cause harmful interference to radio communications. However, there is no guarantee that interference will not occur in a particular installation. If this equipment does cause harmful interference to radio or television reception, which can be determined by turning the equipment off and on, the user is encouraged to try to correct the interference by one or more of the following measures:

- Reorient or relocate the receiving antenna.
- Increase the separation between the equipment and receiver.
- Connect the equipment into an outlet on a circuit different from that to which the receiver is connected.
- Consult the dealer or an experienced radio/TV technician for help.

D8-10-1-2_En

WARNING

This product equipped with a three-wire grounding (earthed) plug - a plug that has a third (grounding) pin. This plug only fits a grounding-type power outlet. If you are unable to insert the plug into an outlet, contact a licensed electrician to replace the outlet with a properly grounded one. Do not defeat the safety purpose of the grounding plug.

D3-4-2-1-6_A_En

CAUTION

The POWER switch on this unit will not completely shut off all power from the AC outlet. Since the power cord serves as the main disconnect device for the unit, you will need to unplug it from the AC outlet to shut down all power. Therefore, make sure the unit has been installed so that the power cord can be easily unplugged from the AC outlet in case of an accident. To avoid fire hazard, the power cord should also be unplugged from the AC outlet when left unused for a long period of time (for example, when on vacation).

D3-4-2-2-2a_A_En

Information to User

Alteration or modifications carried out without appropriate authorization may invalidate the user's right to operate the equipment.

D8-10-2_En

CAUTION: This product satisfies FCC regulations when shielded cables and connectors are used to connect the unit to other equipment. To prevent electromagnetic interference with electric appliances such as radios and televisions, use shielded cables and connectors for connections.

D8-10-3a_En

This Class B digital apparatus complies with Canadian ICES-003.

Cet appareil numérique de la Classe B est conforme à la norme NMB-003 du Canada.

D8-10-1-3_EF

CAUTION – PREVENT ELECTRIC SHOCK DO NOT USE THIS (POLARIZED) PLUG WITH AN EXTENSION CORD, RECEPTACLE OR OTHER OUTLET UNLESS THE BLADES CAN BE FULLY INSERTED TO PREVENT BLADE EXPOSURE.

ATTENTION – POUR PREVENIR LES CHOCS ELECTRIQUES NE PAS UTILISER CETTE FICHE POLARISEE AVEC UN PROLONGATEUR UNE PRISE DE COURANT OU UNE AUTRE SORTIE DE COURANT, SAUF SI LES LAMES PEUVENT ETRE INSEREES A FOND SANS EN LAISSER AUCUNE PARTIE A DECOUVERT.

D2-4-4-1_EF

WARNING: Handling the cord on this product or cords associated with accessories sold with the product will expose you to chemicals listed on proposition 65 known to the State of California and other governmental entities to cause cancer and birth defect or other reproductive harm.

Wash hands after handling

D38-P4_A_En

WARNING

To prevent a fire hazard, do not place any naked flame sources (such as a lighted candle) on the equipment.

D3-4-2-1-7a_A_En

VENTILATION CAUTION

When installing this unit, make sure to leave space around the unit for ventilation to improve heat radiation (at least 5 cm at rear, and 3 cm at each side).

WARNING

Slots and openings in the cabinet are provided for ventilation to ensure reliable operation of the product, and to protect it from overheating. To prevent fire hazard, the openings should never be blocked or covered with items (such as newspapers, table-cloths, curtains) or by operating the equipment on thick carpet or a bed.

D3-4-2-1-7b_A_En

POWER-CORD CAUTION

Handle the power cord by the plug. Do not pull out the plug by tugging the cord and never touch the power cord when your hands are wet as this could cause a short circuit or electric shock. Do not place the unit, a piece of furniture, etc., on the power cord, or pinch the cord. Never make a knot in the cord or tie it with other cords. The power cords should be routed such that they are not likely to be stepped on. A damaged power cord can cause a fire or give you an electrical shock. Check the power cord once in a while. When you find it damaged, ask your nearest PIONEER authorized service center or your dealer for a replacement.

5002_En



Dear Customer:

Selecting fine audio equipment such as the unit you've just purchased is only the start of your musical enjoyment. Now it's time to consider how you can maximize the fun and excitement your equipment offers. This manufacturer and the Electronic Industries Association's Consumer Electronics Group want you to get the most out of your equipment by playing it at a safe level. One that lets the sound come through loud and clear without annoying blaring or distortion-and, most importantly, without affecting your sensitive hearing.

Sound can be deceiving. Over time your hearing "comfort level" adapts to higher volumes of sound. So what sounds "normal" can actually be loud and harmful to your hearing. Guard against this by setting your equipment at a safe level BEFORE your hearing adapts.

To establish a safe level:

- Start your volume control at a low setting.
- Slowly increase the sound until you can hear it comfortably and clearly, and without distortion.

Once you have established a comfortable sound level:

- Set the dial and leave it there.

Taking a minute to do this now will help to prevent hearing damage or loss in the future. After all, we want you listening for a lifetime.

We Want You Listening For A Lifetime

Used wisely, your new sound equipment will provide a lifetime of fun and enjoyment. Since hearing damage from loud noise is often undetectable until it is too late, this manufacturer and the Electronic Industries Association's Consumer Electronics Group recommend you avoid prolonged exposure to excessive noise. This list of sound levels is included for your protection.

Decibel

Level Example

30	Quiet library, soft whispers
40	Living room, refrigerator, bedroom away from traffic
50	Light traffic, normal conversation, quiet office
60	Air conditioner at 20 feet, sewing machine
70	Vacuum cleaner, hair dryer, noisy restaurant
80	Average city traffic, garbage disposals, alarm clock at two feet.

THE FOLLOWING NOISES CAN BE DANGEROUS UNDER CONSTANT EXPOSURE

90	Subway, motorcycle, truck traffic, lawn mower
100	Garbage truck, chain saw, pneumatic drill
120	Rock band concert in front of speakers, thunderclap
140	Gunshot blast, jet plane
180	Rocket launching pad

Information courtesy of the Deafness Research Foundation.



5001_En

CAUTIONS REGARDING HANDLING

Location

Install the unit in a well-ventilated location where it will not be exposed to high temperatures or humidity.

- Do not install the unit in a location which is exposed to direct rays of the sun, or near stoves or radiators. Excessive heat can adversely affect the cabinet and internal components. Installation of the unit in a damp or dusty environment may also result in a malfunction or accident. (Avoid installation near cookers etc., where the unit may be exposed to oily smoke, steam or heat.)
- When the unit is used inside a carrying case or DJ booth, separate it from the walls or other equipment to improve heat radiation.

Cleaning the Unit

- Use a polishing cloth to wipe off dust and dirt.
- When the surfaces are very dirty, wipe with a soft cloth dipped in some neutral cleanser diluted five or six times with water and wrung out well, then wipe again with a dry cloth. Do not use furniture wax or cleaners.
- Never use thinners, benzene, insecticide sprays or other chemicals on or near this unit, since these will corrode the surfaces.

CONTENTS

CAUTIONS REGARDING HANDLING	3
CONFIRM ACCESSORIES	4
FEATURES	4

BEFORE USING

CONNECTIONS	5
CONNECTION PANEL	5
CONNECTING INPUTS	6
CONNECTING EXTERNAL EFFECTORS, OUTPUT CONNECTORS	7
ABOUT MIDI CONNECTORS	7
CONNECTING MICROPHONE AND HEADPHONES	8
CONNECTING THE POWER CORD	8
NAMES AND FUNCTIONS OF PARTS	9
OPERATION PANEL	9
DISPLAY SECTION	12

OPERATIONS

MIXER OPERATIONS	13
BASIC OPERATIONS	13
FADER START FUNCTION	14
EFFECT FUNCTIONS	15
TYPES OF BEAT EFFECTS	15
PRODUCING BEAT EFFECTS	17
TYPE OF SOUND-COLOR EFFECT	18
USING SOUND-COLOR EFFECTS	18
EFFECT PARAMETERS	19
MIDI SETTINGS	20
SYNCHRONIZING AUDIO SIGNALS TO EXTERNAL SEQUENCER, OR USING DJM-800 INFORMATION TO OPERATE AN EXTERNAL SEQUENCER	20
MIDI MESSAGES	20
PROGRAM CHANGE	21
SNAPSHOT	21

OTHER

TROUBLESHOOTING	22
SPECIFICATIONS	23
BLOCK DIAGRAM	24

CONFIRM ACCESSORIES

Operating Instructions	1
Power cord	1
Warranty	1

FEATURES

① Designed for high sound quality

Analog signals are transmitted by the shortest circuitry and converted to digital format at 96 kHz sampling rate via a 24-bit high quality A/D converter. As a result, signals are passed to the digital mixing stage in the best possible state. Mixing is performed with a 32-bit DSP, totally eliminating any loss in fidelity, while the ideal level of filtering is introduced to produce optimum sound for DJ play. These features are housed in a high-rigidity chassis with double-shielded construction together with a high-performance power section and other features of the high-fidelity technology also used in the DJM-1000, thus guaranteeing the utmost in clear and powerful club sounds.

② Sound-color effects

1) Harmonic effect

Equipped with the industry's first "harmonic effect" function that detects the track's key and provides optimum tuning for DJ play. This new function allows smoother, more natural DJ mixing compared to earlier models which allowed DJ play with track tempo adjustment alone.

2) Modulation effect

"Filter," "crush," and "sweep" effects have been added to each channel. These allow a greater breadth to DJ play by permitting the user to apply effects more intuitively. Also, by combining these with "beat effects," some 50 kinds of effect can be produced, giving the user a vast potential for remix and DJ play.

③ Beat effects

The "beat effects" so popular on the DJM-600 are continued here. Effects can be applied in linkage to the BPM (Beats Per Minute) count, thus allowing the production of a variety of sounds. Some of the effects include delay, echo, reverse delay, pan, trance, filter, flanger, phaser, reverb, robot, chorus, roll, and reverse roll.

④ Digital IN/OUT

The digital input connectors support each of the sampling rates (44.1/48/96 kHz), thus allowing the connection of digital components for a DJ system with no sound degradation. Likewise the digital output connectors support sampling rates 96 kHz/24-bit format and 48 kHz/24-bit format, making the unit even more convenient for cutting studio tracks or on other occasions when high sound fidelity is required. (Only linear PCM is supported.)

⑤ MIDI OUT

Virtually all the dial and switch information of the DJM-800 can be output in MIDI signal format, allowing external components to be controlled via MIDI.

⑥ Other functions

- A control cable can be used to connect the unit to a Pioneer DJ CD player, thus allowing playback to be linked to operation of the fader ("fader start play").
- Built-in "3-band equalizer" supports level control within the range of +6 dB to -26 dB in each bandwidth.
- "Cross fader assignment" function allows each channel's input to be assigned flexibly to a cross fader.
- "Talk over" function automatically lowers track volume during microphone input.
- "Fader curve adjustment" function allows modification of the cross fader and channel fader curves.
- "Microphone cut" function mutes microphone output to the booth monitor, thus preventing uncomfortable feedback.
- By replacing the channel fader section with the optional rotary volume kit **DJC-800RV**, the slider control can be replaced with a rotary type control.

CONNECTIONS

CONNECTION PANEL

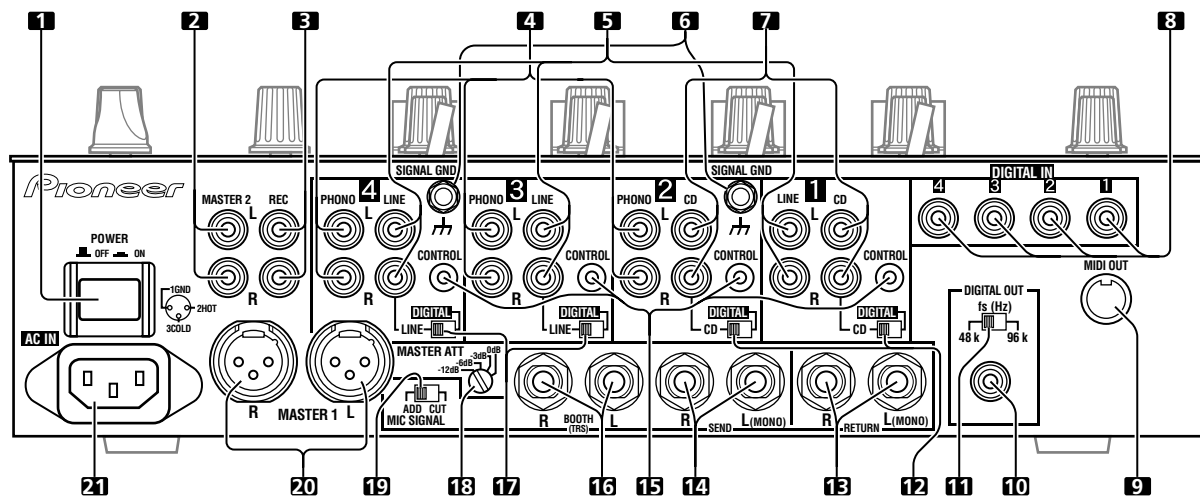

1. POWER switch

2. MASTER 2 output connectors

RCA type unbalanced output.

3. Recording output connectors (REC)

RCA type output connectors for recording.

4. PHONO input connectors

RCA type phono level (MM cartridge) input connectors.

Do not use for inputting line level signals.

5. LINE input connectors

RCA type line level input connectors.

Use to connect a cassette deck or other line level output component.

6. Signal grounding terminals (SIGNAL GND)

Use to connect ground wires from analog players.

This is not a safety grounding terminal.

7. CD input connectors

RCA type line level input connectors.

Use to connect a DJ CD player or other line level output component.

8. DIGITAL IN connectors

RCA type digital coaxial input connectors.

Use to connect to DJ CD player or other digital coaxial output connectors.

- The sound may be temporarily interrupted when the output signal's sampling frequency is changed.

9. MIDI OUT connector

DIN type output connector.

Use to connect to other MIDI component (see P. 20).

10. DIGITAL OUT connector

RCA type digital coaxial output connector.

Master audio digital output.

11. Sampling frequency selector switch (fs 48 k/96 k)

Use to set the sampling frequency of the digital output to 96 kHz/24-bit format or 48 kHz/24-bit format.

- Turn power off before changing this switch position.

12. DIGITAL/CD input selector switches

Use to select either analog input (CD) or digital input (DIGITAL IN).

13. RETURN connectors

Ø6.3 mm phone-type input connectors.

Use to connect to the output connectors of external effectors or similar components.

When the L channel only is connected, the L channel input is simultaneously input to the R channel.

14. SEND output connectors

Ø6.3 mm phone-type output connectors.

Use to connect to the input connectors of external effectors or other similar components. When the L channel only is connected, a L+R monaural signal is output.

15. CONTROL connectors

Ø3.5 mm mini-connector. Use to connect to the control connector of a Pioneer DJ CD player.

When the connectors are connected, the DJM-800's fader can be used to perform start/stop on the DJ CD player.

16. BOOTH monitor output connectors

Ø6.3 mm phone-type booth monitor output connectors.

The sound level from these connectors is controlled independently by the **BOOTH MONITOR** level dial, regardless of the position of the **MASTER LEVEL** dial. (These connectors are TRS output, so they support both balanced and unbalanced outputs.)

17. DIGITAL/LINE input selector switches

Use to select either analog input (LINE) or digital input (DIGITAL IN).

18. Master output attenuator switch (MASTER ATT)

Use to attenuate the level of the master 1 and master 2 outputs. Selectable values are 0 dB, -3 dB, -6 dB and -12 dB.

19. Microphone signal switch (MIC SIGNAL ADD/CUT)

When set to the [ADD] position, the sounds from microphone 1 and microphone 2 are output to the **BOOTH** monitor output connectors. When set to the [CUT] position, the sounds from microphone 1 and microphone 2 are not output to the **BOOTH** monitor output connectors.

20. MASTER 1 output connectors

XLR type (male) balanced output.

- When using a cord with RCA-type plug, users are recommended to connect the plug directly to the **MASTER 2** connectors without using an XLR/RCA converter plug.

21. Power inlet (AC IN)

Use the accessory power cord to connect to an AC power outlet of the proper voltage.

Always turn off the power switch and disconnect the power plug from its outlet when making or changing connections.

CONNECTING INPUTS

Pioneer DJ CD players

Connect a DJ CD player's audio output connectors to one of the channel 1 to 2 **CD** input connectors or the channel 3 to 4 **LINE** input connectors, and connect the player's control cable to the corresponding channel's **CONTROL** connector.

Set the connected channel's **DIGITAL/CD** switch or **DIGITAL/LINE** switch to either **[CD]** or **[LINE]**, and set the input selector switch to **[CD/DIGITAL]** or **[LINE/DIGITAL]**.

When making digital connections, connect the digital coaxial output terminal of the DJ CD player to one of the channel 1 to 4 **DIGITAL IN** connectors of the DJM-800; then set the corresponding channel's **DIGITAL/CD** switch or **DIGITAL/LINE** switch to **[DIGITAL]**, and the input selector switch to **[CD/DIGITAL]** or **[LINE/DIGITAL]**.

Analog turntable

To connect an analog turntable, connect the turntable's audio output cable to one of the channel 2 to 4 **PHONO** input connectors. Set the corresponding channel's input selector switch to **[PHONO]**. The DJM-800's **PHONO** inputs support MM cartridges.

Connect the turntable's ground wire to one of the DJM-800's **SIGNAL GND** terminals.

- Note that no **PHONO** input connector is provided for channel 1.

Connecting other line level output devices

To use a cassette deck or other CD player, connect the component's audio output connectors to one of the channel 3 to 4 **LINE** input connectors. Then set the corresponding channel's **DIGITAL/LINE** switch to **[LINE]**, and the input selector switch to **[LINE/DIGITAL]**.

Alternately, connect the component to the channel 1 **LINE** input connector, then set the channel 1 input selector switch to **[LINE]**.

Connecting other digital output devices

To use a CD player or other component with digital connections, connect the component's digital coaxial output connectors to one of the channel 1 to 4 **DIGITAL IN** connectors; then set the corresponding channel's **DIGITAL/CD** switch or **DIGITAL/LINE** switch to **[DIGITAL]**, and the input selector switch to **[CD/DIGITAL]** or **[LINE/DIGITAL]**.

- The sound may be temporarily interrupted when the output signal's sampling frequency is changed.

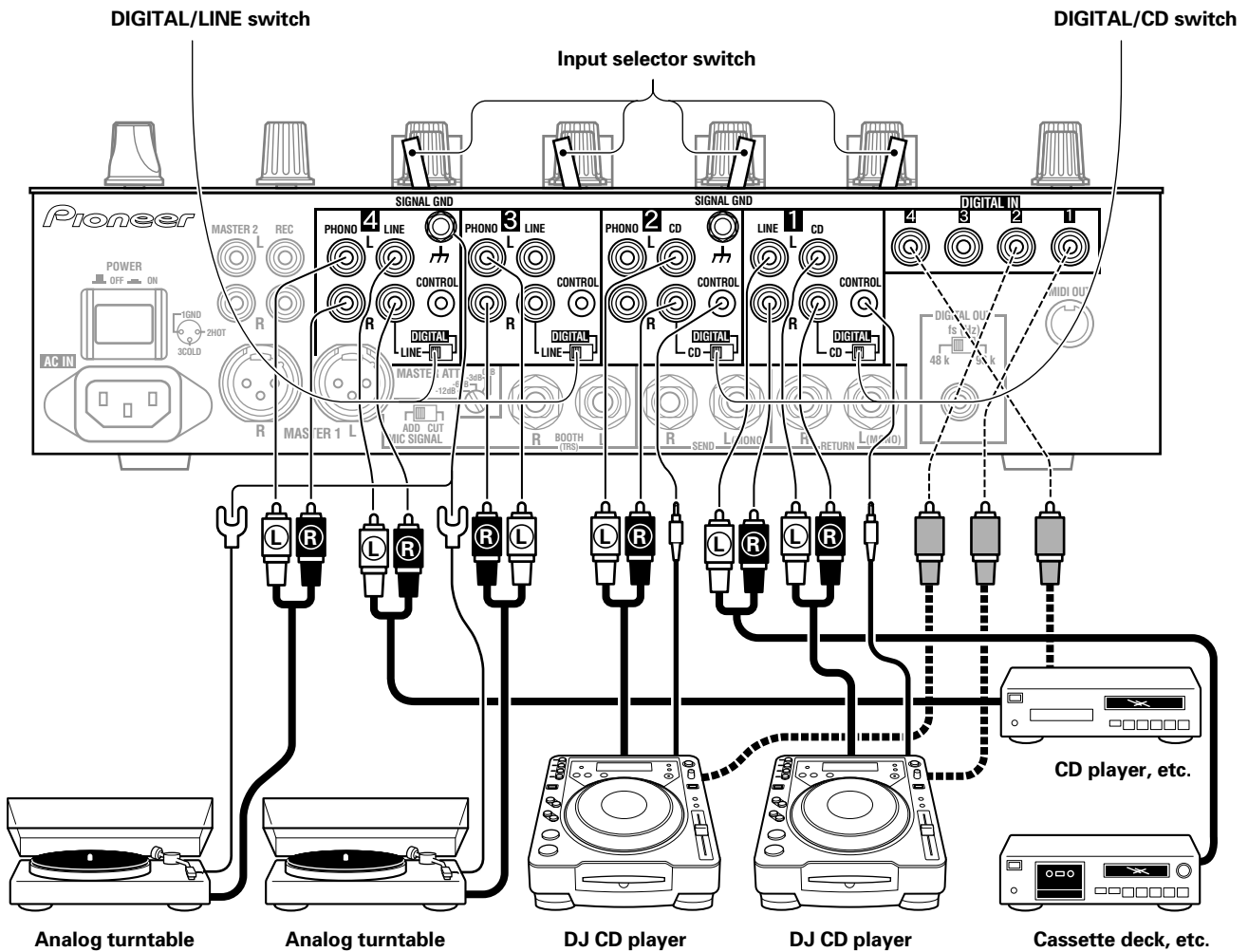

CONNECTING EXTERNAL EFFECTORS, OUTPUT CONNECTORS

Master output

This unit is furnished with balanced output **MASTER 1** (supporting XLR plugs), and unbalanced output **MASTER 2** (supporting RCA plugs).

Using the **MASTER ATT** switch, adjust the output level to match the input sensitivity of the power amplifier used.

If the operating panel's **STEREO/MONO** switch is set to **[MONO]**, the master output will be a monaural combination of L+R channels.

Booth monitor output

This is a TRS output supporting Ø6.3 mm phone plugs. The sound volume for this output is controlled by the **BOOTH MONITOR** level dial, independently of the master output level setting.

Recording output

These are output connectors for recording, supporting RCA plugs.

Digital output

This is a coaxial digital output connector, supporting RCA plugs. The sampling frequency can be set to 96 kHz/24-bit format or 48 kHz/24-bit format to match the connected device.

- Turn power off before changing this switch position.

External effector

Use a cable with Ø6.3 mm phone plugs to connect the DJ mixer's **SEND** connectors to the effector's input connectors.

When using an effector with monaural inputs, connect only to the DJ mixer's L channel output. In this way, the mixed L+R audio signal will be sent to the effector. In the same way, use a cable with Ø6.3 mm phone plugs to connect the DJ mixer's **RETURN** connectors to the output connectors of the effector.

If the effector has only monaural output, connect to the DJ mixer's L channel input only. The signal from the effector will be input to both L and R channels.

When using an external effector, set the effect selector to **[SND/RTN]**.

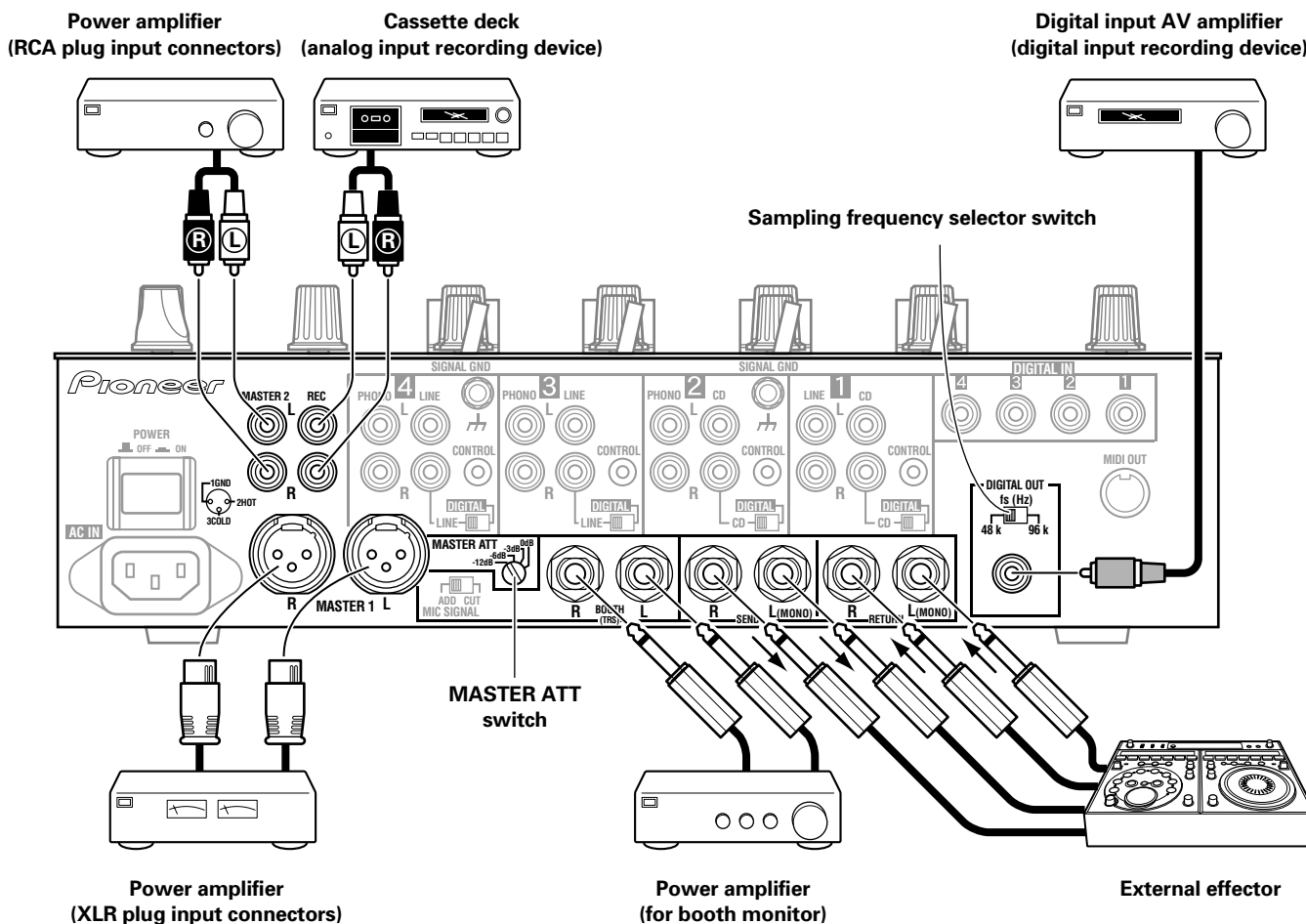

ABOUT MIDI CONNECTORS

See P.20 regarding the functions of MIDI connectors.

CONNECTING MICROPHONE AND HEADPHONES

Microphone

The **MIC 1** jack on the upper surface of the operating panel can be used to connect a microphone with Ø6.3 mm phone plug or XLR plug.

The **MIC 2** jack on the upper surface of the operating panel can be used to connect a microphone with Ø6.3 mm phone plugs.

- When the connection panel's **MIC SIGNAL** switch is set to **[CUT]**, no microphone sounds will be output from the **BOOTH** monitor output connectors.
- When using a microphone, set the operating panel's MIC switch to **[ON]** or **[TALK OVER]**, and adjust the LEVEL dial as necessary. When not using a microphone, it is recommended to set the MIC switch to **[OFF]** and rotate the LEVEL dial fully counterclockwise to the $[-\infty]$ side.

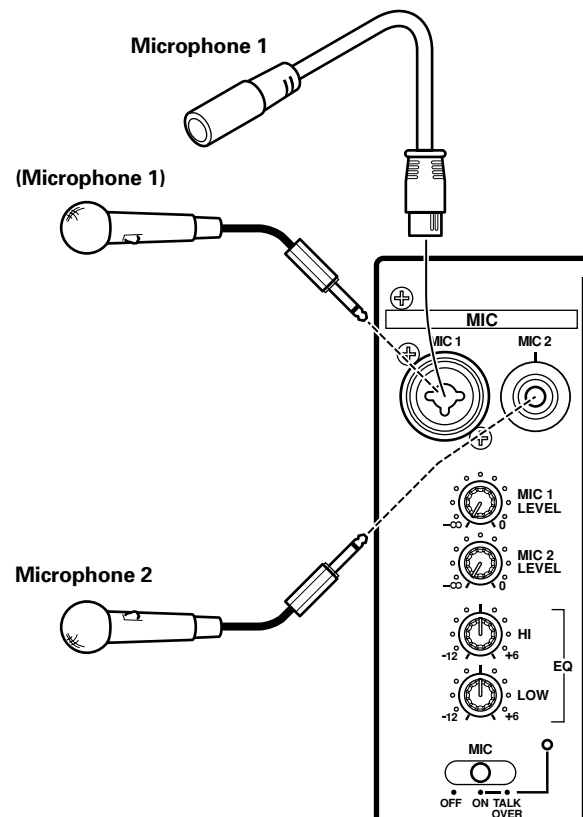

Headphones

The **PHONES** jack on the upper surface of the operating panel can be used to connect headphones with a Ø6.3 mm stereo phone plug.

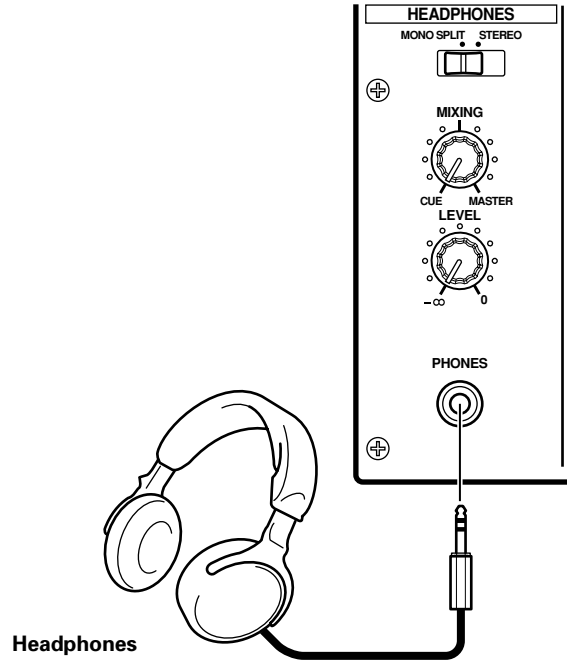

CONNECTING THE POWER CORD

Connect the power cord last.

- After completing all other connections, connect the accessory power cord to the AC inlet on the back of the player, then connect the plug to a standard wall outlet or to the auxiliary power outlet of your amplifier.
- Use only the supplied power cord.

NAMES AND FUNCTIONS OF PARTS

OPERATION PANEL

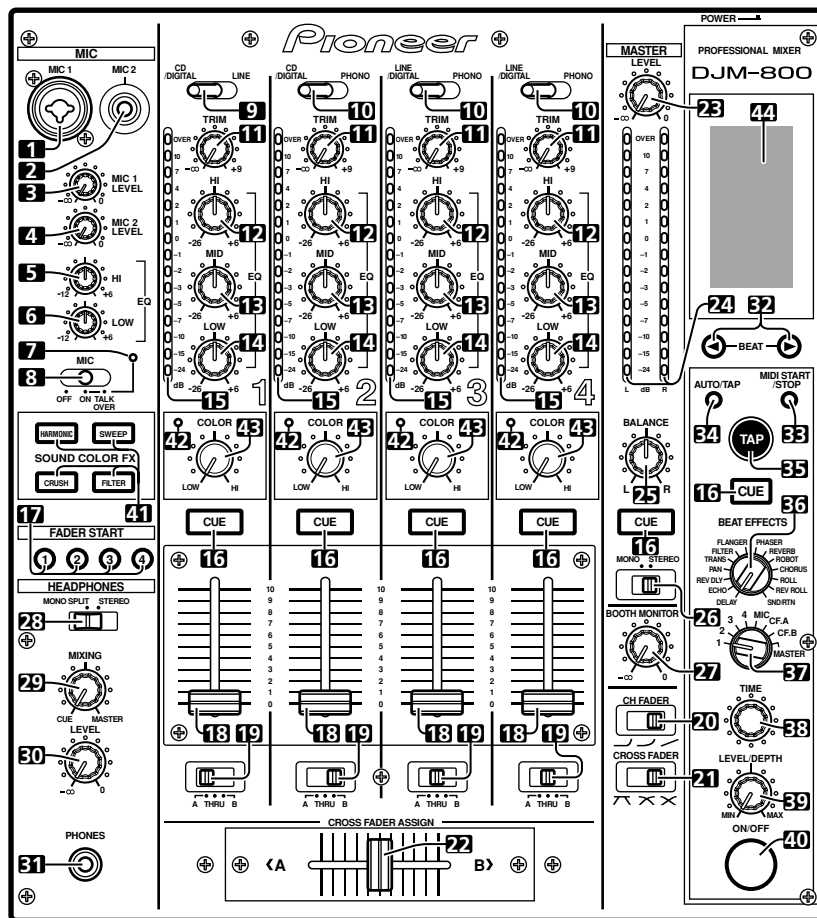

Microphone input control section

- 1. Microphone 1 input jack (MIC 1)**
Use to connect a microphone with an XLR or phone plug.
- 2. Microphone 2 input jack (MIC 2)**
Use to connect a microphone with a phone plug.
- 3. Microphone 1 level control dial (MIC 1 LEVEL)**
Use to adjust the volume of microphone 1. (adjustable range $-\infty$ to 0 dB)
- 4. Microphone 2 level control dial (MIC 2 LEVEL)**
Use to adjust the volume of microphone 2. (adjustable range $-\infty$ to 0 dB)
- 5. Microphone equalizer high-range control dial (HI)**
Use to adjust the treble (high-range) frequencies of microphones 1 and 2. (adjustable range -12 dB to $+6$ dB)
- 6. Microphone equalizer low-range control dial (LOW)**
Use to adjust the bass (low-range) frequencies of microphones 1 and 2. (adjustable range -12 dB to $+6$ dB)
- 7. Microphone function indicator**
Lights when microphone is ON; flashes when TALK OVER is ON.
- 8. Microphone function selector switch (MIC)**
OFF:
No microphone sound is output.

ON:

Microphone sound is output normally.

TALK OVER:

Microphone sound is output; when sound is input to a connected microphone, the TALK OVER function operates and all sound other than that from the microphone is attenuated by 20 dB.

- When not using the TALK OVER function, it is recommended to set the switch to the [OFF] or [ON] position.

Channel input control section

9. Channel 1 input selector switch

CD/DIGITAL:

Use to select **CD** input connectors (line level analog input) or **DIGITAL** input connectors.

LINE:

Use to select **LINE** input connectors.

10. Channel 2 to 4 input selector switches

CD/DIGITAL (channel 2):

Use to select **CD** input connectors (line level analog input) or **DIGITAL** input connectors.

LINE/DIGITAL (channel 3 to 4):

Use to select **LINE** input connectors (line level analog input) or **DIGITAL** input connectors.

PHONO:

Use to select **PHONO** input connectors (analog turntable input).

11. TRIM adjust dial

Use to adjust the input level for each channel. (adjustable range: $-\infty$ to +9 dB, mid-position is about 0 dB)

12. Channel equalizer high-range adjust dial (HI)

Use to adjust the treble (high-range) frequency sound for each channel. (adjustable range: -26 dB to +6 dB)

13. Channel equalizer mid-range adjust dial (MID)

Use to adjust the mid-range frequency sound for each channel. (adjustable range: -26 dB to +6 dB)

14. Channel equalizer low-range adjust dial (LOW)

Use to adjust the bass (low-range) frequency sound for each channel. (adjustable range: -26 dB to +6 dB)

15. Channel level indicator

Displays the current level for each channel, with two-second peak hold.

16. Headphone CUE buttons/indicators

These buttons are used to select from channel 1 to 4, MASTER, or effector, to allow you to monitor the desired source through headphones. If multiple buttons are pressed simultaneously, the selected audio sources are mixed. Press the button once more to cancel the selected source. Unselected buttons glow darkly, while selected source buttons light brightly.

Fader control section

17. Fader start button/indicator (FADER START 1 to 4)

Enables the fader start/back cue function for the channel to which a DJ CD player is connected. The button lights when set to ON. When enabled, the operation differs depending on the setting of the **CROSS FADER ASSIGN** switch.

- When the **CROSS FADER ASSIGN** switch is set to the [A] or [B] position, fader start button operation is linked to the operation of the cross fader (and unlinked to channel fader).
- When the **CROSS FADER ASSIGN** switch is set to the [THRU] position, fader start button operation is linked to the operation of the channel fader (and unlinked to cross fader).

18. Channel fader lever

Use to adjust sound volumes for each channel. (adjustable range: $-\infty$ to 0 dB)

Output is in accordance with the channel fader curve selected with the **CH FADER** curve switch.

19. CROSS FADER ASSIGN switch

This switch assigns each channel's output to either right or left side of the cross fader (if multiple channels are assigned to the same side, the result will be the combined sum of the channels).

A:

The selected channel is assigned to the cross fader's A (left) side.

THRU:

The channel fader's output is sent as is to the master output, without being passed through the cross fader.

B:

The selected channel is assigned to the cross fader's B (right) side.

20. Channel fader curve switch (CH FADER)

This switch allows the user to select from three types of channel fader curve response. This setting is applied equally to channels 1 to 4.

- At the left setting, the curve operates to produce a rapid rise as the channel fader approaches its distant position.
- At the right setting, the curve operates to produce an even, neutral rise throughout the channel fader's movement.
- At the middle setting, an intermediate curve is produced, midway between the two curves noted above.

21. Cross fader curve switch (CROSS FADER)

This switch allows the user to select from three types of cross fader curve response.

- At the left setting, the curve produces a rapid signal rise. (As soon as the cross fader lever leaves the [A] side, the [B] channel sound is produced.)
- At the right setting, the curve operates to produce an even, neutral rise throughout the cross fader's movement.
- At the middle setting, an intermediate curve is produced, midway between the two curves noted above.

22. Cross fader lever

Outputs sound assigned to [A] and [B] sides in accordance with setting of the **CROSS FADER ASSIGN** switch, and subject to the cross fader curve selected with the **CROSS FADER** curve switch.

Master output control section

23. Master output level dial (MASTER LEVEL)

Use to adjust the master output level. (adjustable range: $-\infty$ to 0 dB)

The master output is the sum combination of the sound from channels set to [THRU] with the **CROSS FADER ASSIGN** switch; the signal passed through the cross fader; and the signals from microphone 1 and microphone 2 (if the effect selector is set to [SND/RTN], the **RETURN** input is also added).

24. Master level indicator (MASTER L, R)

These segment indicators display the output level from L and R channels. The indicators have a two-second peak hold.

25. Master balance dial (BALANCE)

Use to adjust the L/R channel balance for master output, booth monitor output, recording output, and digital output.

26. Master output STEREO/MONO selector switch

When set to [MONO], the master output becomes a monaural combination of L+R.

Booth monitor control section

27. BOOTH MONITOR level control dial

This dial is used to adjust the booth monitor output volume. The volume can be adjusted independently of the master output level. (adjustable range: $-\infty$ to 0 dB)

Headphones output section

28. Headphones output switch (MONO SPLIT/STEREO)

MONO SPLIT:

The audio source selected with the headphone **CUE** button is output to the L channel, and the master audio is output to the R channel (only when headphone **CUE** button is used to select [MASTER]).

STEREO:

The audio source selected with the headphone **CUE** button is output in stereo.

29. Headphones mixing dial (MIXING)

When rotated clockwise (toward [MASTER]), the master output audio is produced at the headphones (only when [MASTER] has been selected with the headphones **CUE** button); when rotated counterclockwise (toward [CUE]), the headphones output becomes the mixture of the effect monitor and the channel selected with the headphone **CUE** button.

30. Headphones level adjust dial (LEVEL)

Adjusts the output level of the headphones jack. (adjustable range: $-\infty$ to 0 dB)

31. Headphones jack (PHONES)

BPM counter section

32. Beat select buttons (◀ BEAT ▶)

▶ (Beat up): Doubles the calculated BPM.

◀ (Beat down): Halves the calculated BPM.

(P. 17)

- Some effects can be set for "3/4".

33. MIDI start/stop button (MIDI START/STOP)

Use to alternate the MIDI control function between start and stop (P. 20).

When this control is enabled, the [MIDI START (STOP)] message appears for two seconds on the display.

MIDI SNAP SHOT:

When the MIDI START/STOP button is held depressed, a snapshot is sent to the external MIDI component.

34. BPM measuring mode button (AUTO/TAP)

Each time the button is pressed, the BPM measuring mode alternates between [AUTO] and [TAP].

AUTO:

The display's [AUTO] indicator lights, and the BPM is automatically calculated.

TAP:

The display's [TAP] indicator lights, and the BPM is calculated manually by TAP button input.

35. TAP button

The BPM is calculated from the intervals at which the TAP button is struck. If the TAP button is pressed in the AUTO mode, the mode automatically switches to the TAP mode (manual input).

Beat effect section

36. Effect selector (DELAY, ECHO, REV DLY (REVERSE DELAY), PAN, TRANS, FILTER, FLANGER, PHASER, REVERB, ROBOT (ROBOT VOCODER), CHORUS, ROLL, REV ROLL (REVERSE ROLL), SND/RTN (SEND/RETURN))

Use to select desired type of effect (P. 15).

When using an external effector connected to the SEND and RETURN connectors, set to the [SND/RTN] position.

37. Effect channel selector (1, 2, 3, 4, MIC, CF.A, CF.B, MASTER)

Use to select the channel to which effects are applied (P. 17). When [MIC] is selected, effects are applied to both microphone 1 and microphone 2.

38. Effect parameter 1 dial [TIME (PARAMETER 1)]

Adjusts time parameter for selected effect (P. 17, 19)

- If the TIME dial is rotated while depressing the TAP button, direct BPM can be set manually.
- If the TIME dial is rotated while holding the TAP button and AUTO/TAP buttons depressed, the BPM can be set in 0.1 units.

39. Effect parameter 2 dial [LEVEL/DEPTH (PARAMETER 2)]

Adjusts quantitative parameters for selected effect (P. 17, 19).

40. Effect button/indicator (ON/OFF)

Sets selected effect ON/OFF (P. 17). Whenever power is first turned ON, effects default to OFF and the button is lighted. When effects are enabled (ON), the button flashes.

Sound-color effects section

41. Sound-color effect select buttons/indicators (HARMONIC, SWEEP, FILTER, CRUSH)

Use to select and enable/disable sound-color effects (P. 18). The button for the selected function will flash, and the effect will be applied equally to channels 1 to 4. When the flashing button is pressed, it lights steadily and the effect turns OFF. When power is first turned on, all effects default to OFF (indicators are lighted).

42. Harmonic Indicators

When [HARMONIC] is turned ON, these indicators light and the color of the indicator changes in accord with the status of the effect (P. 18).

43. Sound-color effect parameter dial (COLOR)

Used to adjust quantitative parameters for the effect selected with the sound-color effect selector buttons (P. 18, 19)

44. Display

See P. 12 for details.

DISPLAY SECTION

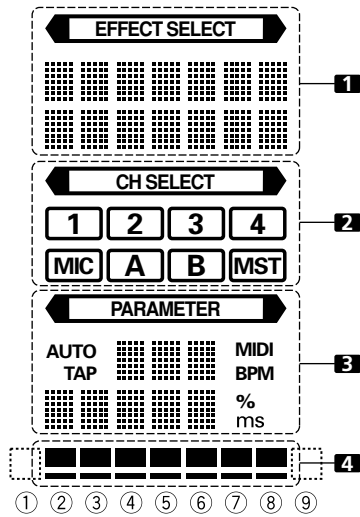

1. Effects display section

The <EFFECT SELECT> indicator lights constantly, and the alpha-numeric display (seven characters in two lines) indicates the name of the effect as shown below. Also, when one of the change operations is performed as noted in the table, the corresponding characters are displayed for two seconds, after which the display returns to the original effect name.

Switching Operation	Upper/Lower Row	Display
At MIDI start	Upper	MIDI
	Lower	START
At MIDI stop	Upper	MIDI
	Lower	STOP
MIDI snapshot	Upper	SNAP
	Lower	SHOT

2. Channel select display section

The <CH SELECT> indicator lights constantly, and a red frame lights around the number position corresponding to the chosen effect channel selector.

3. Parameter display section

<PARAMETER>:

The <PARAMETER> indicator lights constantly.

AUTO/TAP:

[AUTO] lights when the BPM measuring mode is set to AUTO, and [TAP] lights when the BPM measuring mode is set to manual (TAP).

BPM counter display (3 digits):

In AUTO mode, displays the automatically detected BPM value. If the BPM count cannot be detected automatically, the display will flash at the previously detected value. In manual (TAP) mode, displays the BPM value designated by TAP input, etc.

BPM:

Lights constantly.

MIDI:

Displays the MIDI start/stop status.

- Indicator lights after MIDI start command has been sent.
- Indicator goes out after MIDI stop command has been sent.

Parameter 1 display (5 digits):

Displays parameters designated for each effect. When the beat select buttons (BEAT ◀, ▶) are pressed, the corresponding beat multiple change is displayed for one second. If the beat select buttons (BEAT ◀, ▶) are used to designate a value outside the parameter range, the current number will flash but will not change.

Unit Display (%/ms):

Lights in accordance with the unit used for each effect.

4. Beat display section

Displays the location of parameter 1 relative to BPM (1/1 beat). The lower row is lighted constantly. When the parameter 1 location approaches a threshold value, the corresponding indicator is lighted. When the parameter 1 is between threshold values, the indicator flashes. Although the display includes seven actual indicators, the two ends can also be considered to act as indicators, with the result that a theoretical nine positions can be postulated. When the values are at the two ends, no indicators light.

Effect selector	1 Effect display		3 Parameter display				4 Beat display								
	Upper/Lower	Effect name	Minimum value	Maximum value	Default	Unit	①	②	③	④	⑤	⑥	⑦	⑧	⑨
DELAY	Upper	DELAY	1	4 000	500	ms	1/8	1/4	1/2	3/4	1/1	2/1	4/1	8/1	16/1
	Lower														
ECHO	Upper	ECHO	1	4 000	500	ms	1/8	1/4	1/2	3/4	1/1	2/1	4/1	8/1	16/1
	Lower														
REV DLY	Upper	REVERSE	10	4 000	500	ms	1/8	1/4	1/2	3/4	1/1	2/1	4/1	8/1	16/1
	Lower	DELAY													
PAN	Upper	PAN	10	16 000	500	ms	1/16	1/8	1/4	1/2	1/1	2/1	4/1	8/1	16/1
	Lower														
TRANS	Upper	TRANS	10	16 000	500	ms	1/16	1/8	1/4	1/2	1/1	2/1	4/1	8/1	16/1
	Lower														
FILTER	Upper	FILTER	10	32 000	2 000	ms	1/4	1/2	1/1	2/1	4/1	8/1	16/1	32/1	64/1
	Lower														
FLANGER	Upper	FLANGER	10	32 000	2 000	ms	1/4	1/2	1/1	2/1	4/1	8/1	16/1	32/1	64/1
	Lower														
PHASER	Upper	PHASER	10	32 000	2 000	ms	1/4	1/2	1/1	2/1	4/1	8/1	16/1	32/1	64/1
	Lower														
REVERB	Upper	REVERB	1	100	50	%	10	20	30	40	50	60	70	80	90
	Lower														
ROBOT	Upper	ROBOT	-100	100	0	%	—	-100	-66	-50	0	26	50	100	—
	Lower														
CHORUS	Upper	CHORUS	10	32 000	2 000	ms	1/4	1/2	1/1	2/1	4/1	8/1	16/1	32/1	64/1
	Lower														
ROLL	Upper	ROLL	10	4 000	500	ms	1/16	1/8	1/4	1/2	1/1	2/1	4/1	8/1	16/1
	Lower														
REV ROLL	Upper	REVERSE	10	4 000	500	ms	1/16	1/8	1/4	1/2	1/1	2/1	4/1	8/1	16/1
	Lower	ROLL													
SND/RTN	Upper	SEND/													
	Lower	RETURN													

Shaded items are not displayed.

MIXER OPERATIONS

BASIC OPERATIONS

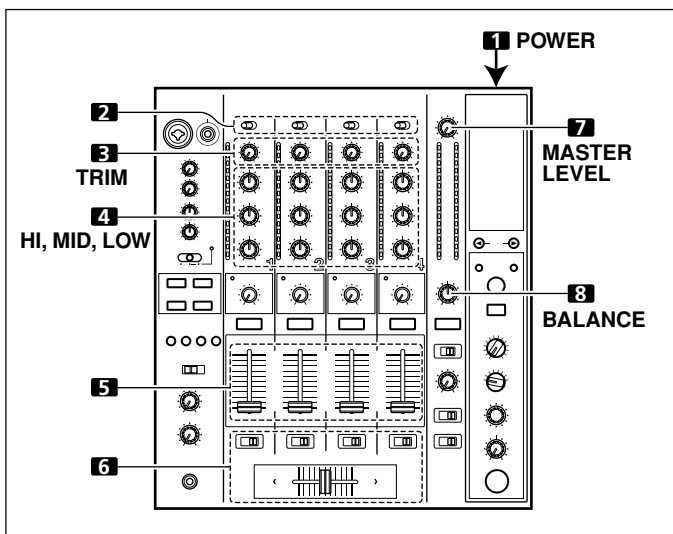

1. Set rear panel **POWER** switch to **ON**.
2. Set the input selector switch for the desired channel to **choose the connected component**.
 - When using **CD** input or **LINE** input, the connection panel's **DIGITAL/CD** switch or **DIGITAL/LINE** switch must be set to **[CD]** or **[LINE]**.
 - When using a **DIGITAL** input, the connection panel's **DIGITAL/CD** switch or **DIGITAL/LINE** switch must be set to **[DIGITAL]**.
3. Use the **TRIM** dial to adjust the input level.
4. Use the channel equalizer dials (**HI, MID, LOW**) to adjust the tone.
5. Use the channel fader lever to adjust the sound volume of the selected channel.
6. To use the cross fader on the selected channel, set the **CROSS FADER ASSIGN** switch to either cross fader channel **A** or channel **B**, and operate the cross fader lever.
 - When not using the cross fader, set the **CROSS FADER ASSIGN** switch to **[THRU]**.
7. Use the **MASTER LEVEL** dial to adjust the overall sound volume.
8. Use the **BALANCE** dial to adjust the sound balance between right and left.

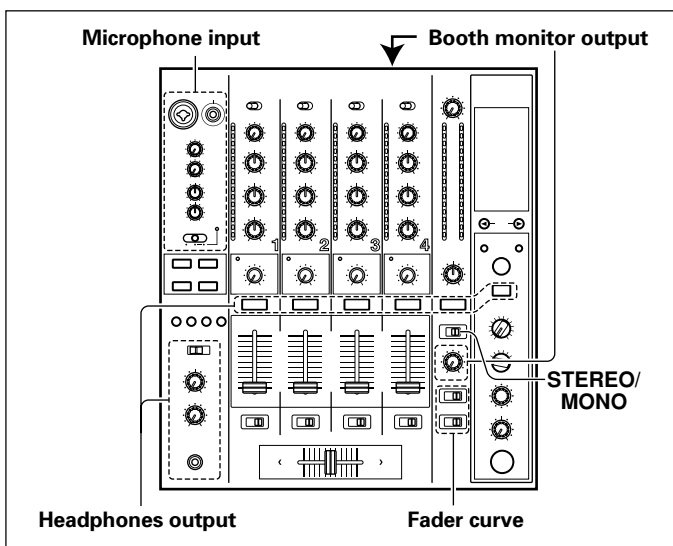

[Selecting Stereo or Monaural]

When the **STEREO/MONO** switch is set to **[MONO]**, the master output becomes a monaural combination of L+R channels.

[Microphone Input]

1. To use a microphone, set the **MIC** switch to **[ON]** or **[TALK OVER]**.
 - When the switch is set to **[TALK OVER]**, any time a sound of over -15 dB is detected by the microphone, the output for all sound sources other than the microphone are attenuated by 20 dB.
2. Use the **MIC 1 LEVEL** dial to adjust the sound volume of **MIC 1**, and use the **MIC 2 LEVEL** dial to adjust the sound volume of **MIC 2**.
3. Use the microphone equalizer dials (**HI, LOW**) to adjust the tone of the microphone sound.
 - The microphone equalizer function operates simultaneously on microphone 1 and 2.

[Booth Monitor Output]

1. Set the connection panel's **MIC SIGNAL** switch to select whether microphone sounds are output to the booth monitor.
 - When set to the **[ADD]** position, microphone sounds are output to the booth monitor, and when set to the **[CUT]** position, microphone sounds are not output to the booth monitor.
2. Use the **BOOTH MONITOR** dial to adjust the sound volume.
 - The **BOOTH MONITOR** dial can be used to adjust the sound volume independently of the **MASTER LEVEL** dial.

[Headphones Output]

1. Use the **CUE** buttons (channels 1 to 4, **MASTER**, **effector**) to select the source.
 - The selected **CUE** button lights brightly.
2. Set the headphones (**MONO SPLIT/STEREO**) switch.
 - When set to the **[MONO SPLIT]** position, the left channel outputs the sound selected with the **CUE** button, while the right channel outputs the master audio (only when the **CUE** button for the **[MASTER]** is **ON**).
 - When set to the **[STEREO]** position, the sound corresponding to the selected **CUE** button is output in stereo.
3. When **[MONO SPLIT]** is selected, use the **MIXING** dial to adjust the balance of sound between the left channel (sound selected with the **CUE** button), and the right channel (the master sound – but only when the **CUE** button for the **[MASTER]** is **ON**).
 - When the **MIXING** dial is rotated clockwise (toward **[MASTER]**), the master output (only when the **CUE** button for the **[MASTER]** is **ON**) increases; when rotated counterclockwise (toward **[CUE]**), the sound selected with the **CUE** button is output.
4. Use the **LEVEL** dial to adjust the headphones' sound volume.

[Fader Curve Selection]

The sound volume response to fader operation can be set to one of three characteristic curves.

- Use the **CH FADER** switch to select the desired channel fader response curve.
 - At the left setting, the curve operates to produce a rapid rise as the channel fader approaches its distant position.
 - At the right setting, the curve operates to produce an even, neutral rise throughout the channel fader's movement.
 - At the middle setting, an intermediate curve is produced, midway between the two curves noted above.
 - This setting applies equally to channels 1 to 4.

■ Use the **CROSS FADER** curve switch to select the cross fader curve response.

- At the left setting, the curve produces a rapid signal rise. (As soon as the cross fader lever leaves the [A] side, the [B] channel sound is produced.)
- At the right setting, the curve operates to produce an even, neutral rise throughout the cross fader's movement.
- At the middle setting, an intermediate curve is produced, midway between the two curves noted above.
- This setting produces equal curve effects for both sides A and B.

FADER START FUNCTION

By connecting the optional Pioneer DJ CD Player control cable, the channel fader and cross fader can be used to start CD playback. When the mixer's channel fader lever or cross fader lever are moved, the CD player is released from the pause mode and automatically – and instantly – begins playback of the selected track. Also, when the fader lever is returned to its original position, the CD player returns to its cue point (back cue), thus allowing "sampler" type play.

Cross fader start play and back cue play

When the CD player assigned to cross fader channel A is set to standby at a cue point, moving the cross fader lever from the right (B) side toward the left (A) side automatically starts play on the channel A CD player.

When the cross fader lever reaches the left (A) side, the CD player assigned to channel B goes to back cue (returns to cue point). Also, when the CD player assigned to channel B is set to standby at a cue point, moving the cross fader lever from the left (A) side to the right (B) side automatically starts playback on the channel B CD player. When the cross fader lever reaches the right (B) side, the CD player assigned to channel A goes to back cue (returns to cue point).

* The back cue is performed even if the input selector switch is not set to [CD/DIGITAL] or [LINE/DIGITAL].

[Using the Channel Fader to Start Playback]

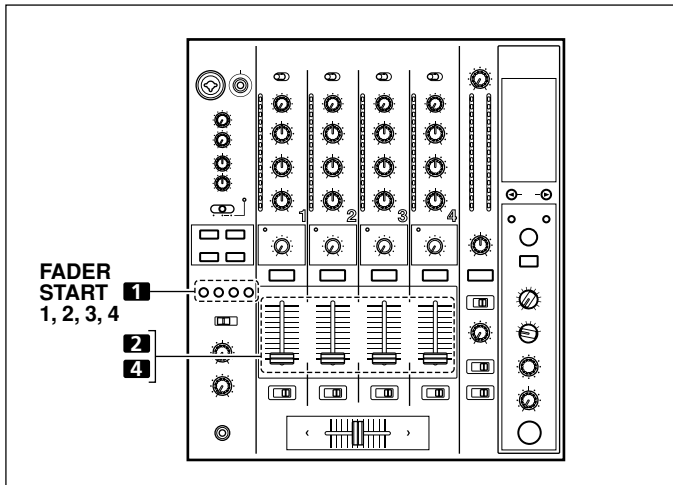

1. Press the **FADER START** button for the channel (1 to 4) connected to the CD player you wish to control.
 - The button for the selected channel lights.
2. Set the channel fader lever to "0".
3. Set the CD player to the desired cue point, and engage cue point standby.
 - If a cue point has already been set, it is not necessary to set the CD player to standby at the cue point.

4. At the instant you wish to start playback, move the channel fader lever.

- CD player begins playback.
- After playback has begun, if the channel fader lever is returned to the [0] position, the CD player returns to the cue point and re-enters standby mode (back cue).

* Playback control is possible with the channel fader only with the **CROSS FADER ASSIGN** switch is set to [THRU].

[Using the Cross Fader to Start Playback]

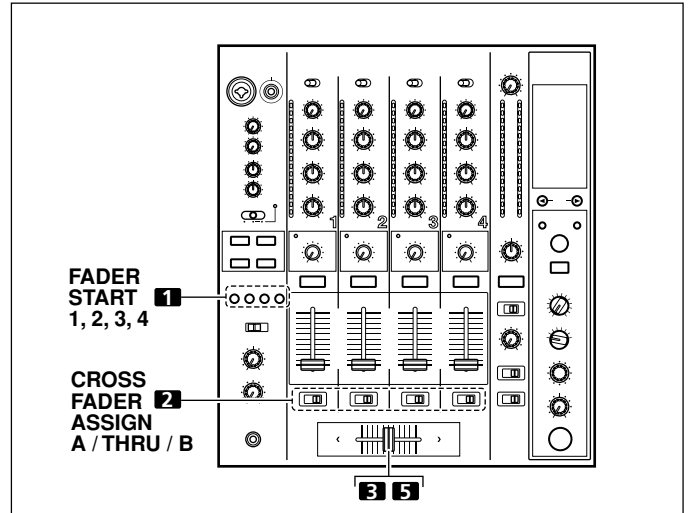

1. Press the **FADER START** button for the channel (1 to 4) connected to the CD player you wish to control.
 - The button for the selected channel lights.
2. Set the **CROSS FADER ASSIGN** switch for the selected channel to [A] or [B].
 - Select [A] to assign to cross fader channel A (left side).
 - Select [B] to assign to cross fader channel B (right side).
3. Move the cross fader lever to the full opposite side away from the CD player you wish to start.
4. Set the CD player to the desired cue point, and engage cue point standby.
 - If a cue point has already been set, it is not necessary to set the CD player to standby at the cue point.
5. At the instant you wish to start playback, move the cross fader lever.
 - CD player begins playback.
 - After playback has begun, if the cross fader lever is moved fully to the opposite side, the CD player assigned to the opposite side channel will return to the cue point and enter standby mode (back cue).

Note:
The fader start function will not be enabled if digital connections are used alone; to use the fader start function, be sure to connect the CD player's analog connectors as well.

EFFECT FUNCTIONS

This unit can produce beat effects linked to the BPM, and sound-color effects linked to the **COLOR** dials provided for each channel, for a total of 18 basic effects (including [SND/RTN]). In addition, by changing the parameters for each kind of effect, an extremely wide range of effect variations can be produced.

A wide variety of beat effects can be achieved by varying the temporal parameter via the **TIME** dial (Parameter 1), as well as quantitative parameter via the **LEVEL/DEPTH** dial (Parameter 2). Sound-color effect changes can be added by varying the position of the **COLOR** dials. By combining beat effects and sound-color effects, an even greater range of performance effects can be produced.

TYPES OF BEAT EFFECTS

1. DELAY (One repeat sound)

This function allows a delay sound with beat of $1/8$, $1/4$, $1/2$, $3/4$, $1/1$, $2/1$, $4/1$, $8/1$, or $16/1$ to be added quickly and simply. For example, When a $1/2$ beat delay sound is added, four beats become eight beats. Also, by adding a $3/4$ beat delay sound, the rhythm becomes syncopated.

Example

Original
(4 beats)

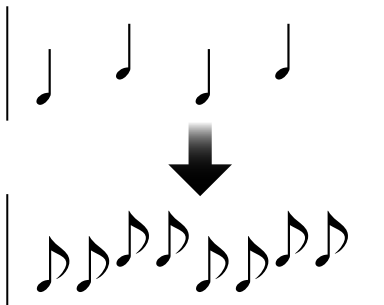

$1/2$ delay
(8 beats)

2. ECHO (Multiple repeat sounds)

This function allows an echo sound with beat of $1/8$, $1/4$, $1/2$, $3/4$, $1/1$, $2/1$, $4/1$, $8/1$, or $16/1$ to be added quickly and simply. For example, when a $1/1$ beat echo sound is used to cutoff the input sound, a sound in synch with the beat is repeated together with fadeout.

Also, by adding a $1/1$ beat echo to the microphone, the microphone sound repeats in synch with the music beat.

If a $1/1$ beat echo is applied to the vocal portion of a track, the song takes on an effect reminiscent of a "round".

Example

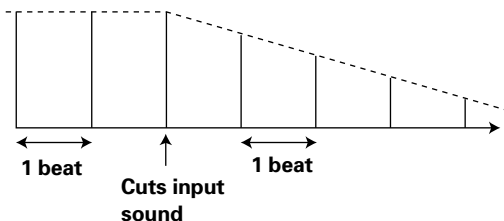

3. REVERSE DELAY (One repeat sound)

This function allows an inverted delay sound with beat of $1/8$, $1/4$, $1/2$, $3/4$, $1/1$, $2/1$, $4/1$, $8/1$, or $16/1$ to be added quickly and simply.

Example

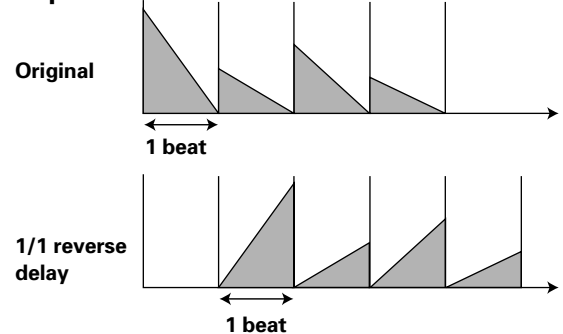

4. Auto PAN (L-R BALANCE)

This function distributes sounds in units of $1/16$, $1/8$, $1/4$, $1/2$, $1/1$, $2/1$, $4/1$, $8/1$, or $16/1$ to right and left channels in synch with the rhythm (auto beat pan).

Also, short auto pan can be performed, allowing sounds to be distributed to right/left very quickly, an effect impossible to perform manually.

Example

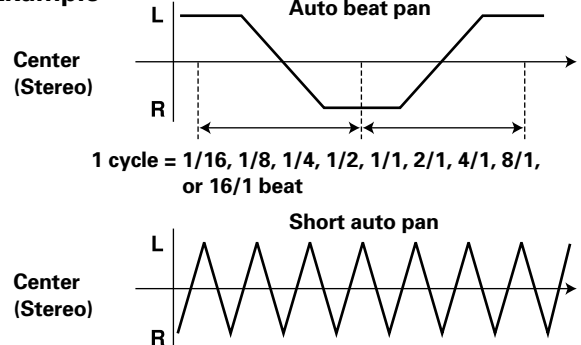

5. Auto TRANS

In units of $1/16$, $1/8$, $1/4$, $1/2$, $1/1$, $2/1$, $4/1$, $8/1$, or $16/1$ beat, the sound is automatically cut in synch with the rhythm.

Example

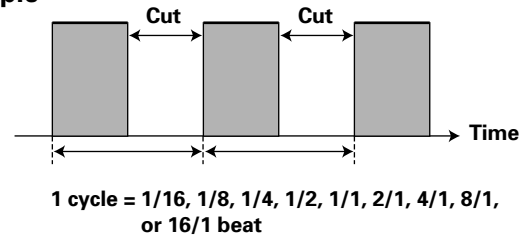

6. FILTER

In units of 1/4, 1/2, 1/1, 2/1, 4/1, 8/1, 16/1, 32/1, or 64/1 beat, the filter frequency is moved, greatly changing the sound coloration.

Example

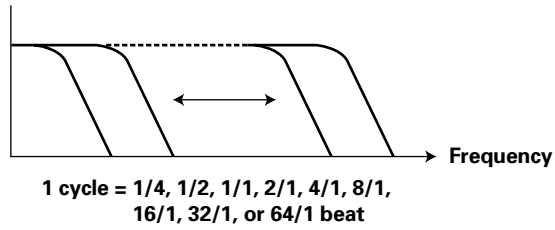

7. FLANGER

In units of 1/4, 1/2, 1/1, 2/1, 4/1, 8/1, 16/1, 32/1, or 64/1 beat, 1 cycle of flanger effect is produced quickly and easily.

Example

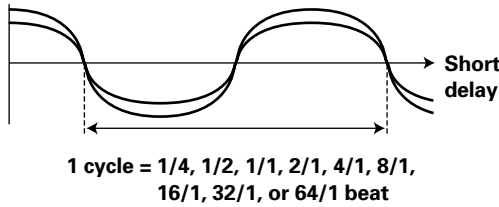

8. PHASER

In units of 1/4, 1/2, 1/1, 2/1, 4/1, 8/1, 16/1, 32/1, or 64/1 beat, 1 cycle of phaser effect is produced quickly and easily.

Example

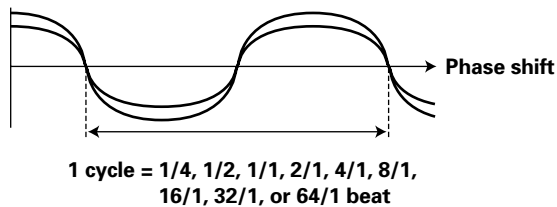

9. REVERB

Produces reverberation effect.

10. ROBOT

Input sounds are reproduced as though generated by a robot.

11. CHORUS

Generates a chorus sound in synch with 1/8, 1/4, 1/2, 1/1, 2/1, 4/1, 8/1, or 16/1 beat. The sound produced has breadth as though the same pitch were issuing from multiple sources.

12. ROLL

Sounds of 1/16, 1/8, 1/4, 1/2, 1/1, 2/1, 4/1, 8/1, or 16/1 beat are recorded and output repetitively. Also, when sounds are changed from 1/1 beat to 1/2 or 1/4 in synch with the beat, a roll sound effect can be produced.

Example

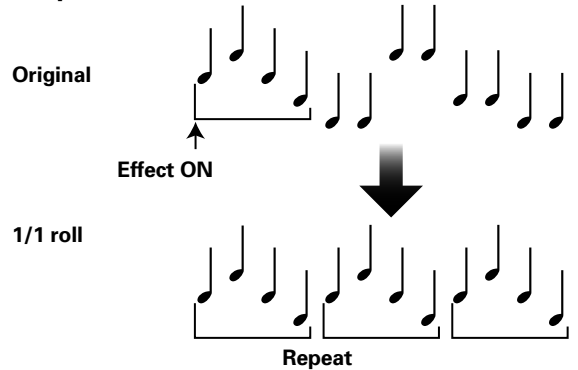

13. REVERSE ROLL

Sounds of 1/16, 1/8, 1/4, 1/2, 1/1, 2/1, 4/1, 8/1, or 16/1 beat are recorded, inverted, and output repetitively. Also, when sounds are changed from 1/1 beat to 1/2 or 1/4 in synch with the beat, an inverted playback roll sound effect can be produced.

Example

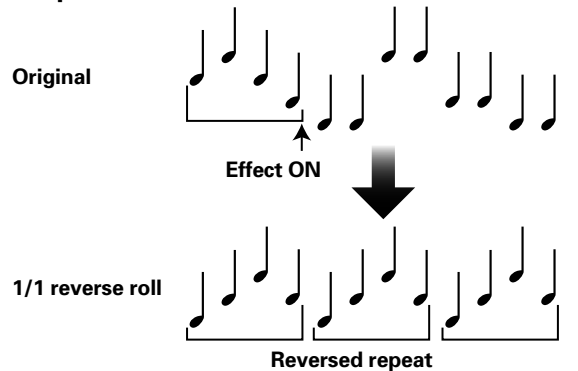

14. SEND/RETURN

By connecting a sampler or effector, a wide variety of other effects can be created.

PRODUCING BEAT EFFECTS

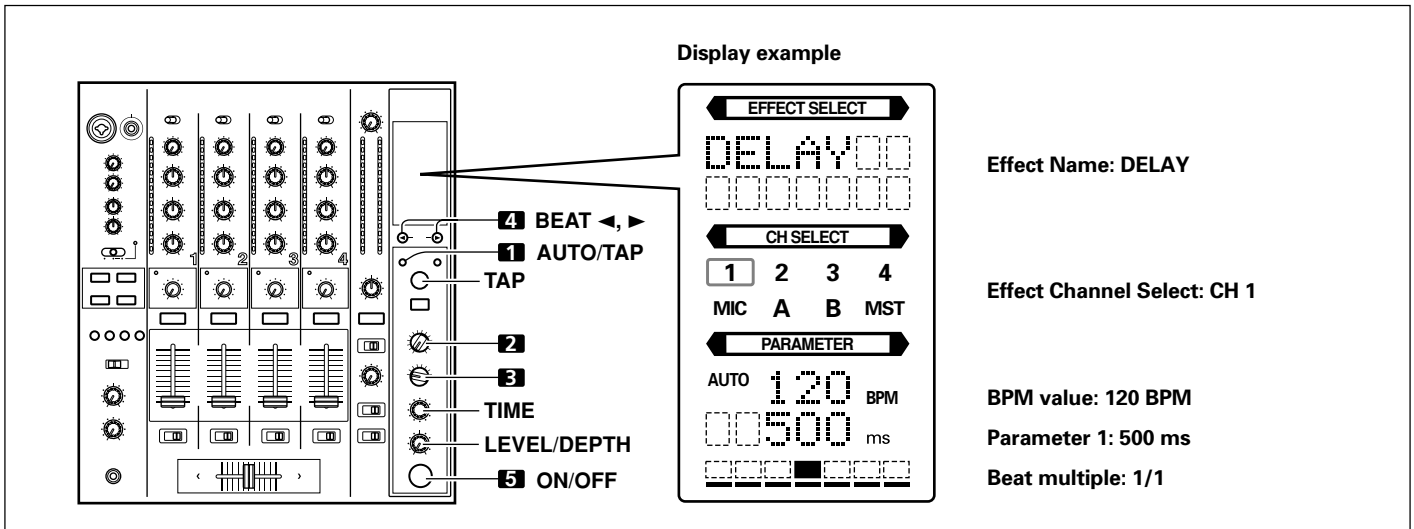

Beat effects allow the instant setting of effect times in synch with the BPM (beats per minute), thus allowing the production of a wide variety of effects in synch with the current rhythm, even during live performances.

1. Press the AUTO/TAP button to set the Beats Per Minute (BPM = track speed) measuring mode.

AUTO: The BPM of the input music signal is detected automatically.
TAP: The BPM is input manually by tapping on the TAP button.

- Whenever power is first turned ON, the function defaults to the [AUTO] mode.
- The indicator for the selected mode [AUTO/TAP] lights in the display.
- In the event the track's BPM cannot be detected automatically, the display's BPM counter will flash.
- The effective range in the AUTO mode is 70 to 180 BPM.
It may not be possible to measure some tracks accurately.
In this case, use the TAP mode for manual BPM input.

[Using the TAP Button for Manual BPM Input]

If the TAP button is tapped two times or more in synch with beat (1/4 notes), the BPM will be recorded as the average value recorded during that interval.

- When BPM mode is set to [AUTO], tapping the TAP button will cause the BPM mode to change to the TAP mode, and the interval at which the TAP button is pressed will be measured.
- When the BPM is set via the TAP button, the beat multiple becomes "1/1" (or "4/1", depending on the effect selected), and the time for 1 beat (1/4 notes) or 4 beats will be set as the effect time.
- If the TIME dial is rotated while depressing the TAP button, direct BPM can be set manually.
If the TIME dial is rotated while holding the TAP button and AUTO/TAP buttons depressed, the BPM can be set in 0.1 units.

2. Set the effect selector to the desired effect.

- The display will show the name of the selected effect.
- See P. 15 to 16 for details regarding the various effects.

3. Set the effect channel selector to the channel you wish to apply the effect to.

- The display's channel name indicator will show the selected channel with red frame.
- If [MIC] is selected, the effect will be applied to both microphone 1 and microphone 2.

4. Press the BEAT button (◀, ▶) to select the beat multiple to which the effect is to be synchronized.

- When ▶ is pressed, the beat count calculated from the BPM is doubled, and when ◀ is pressed, the beat count calculated from the BPM is halved (some effects also allow "3/4" setting).
- The multiple of the selected beat (parameter 1 position) is displayed in seven sections on the display (see P. 12).
- The effect time corresponding to the beat's multiple is set automatically.
Example: When BPM = 120
1/1 = 500 ms
1/2 = 250 ms
2/1 = 1 000 ms

5. Set the ON/OFF button to ON to enable the effect.

- Each time the button is pressed, the effect alternates ON/OFF (whenever power is first turned ON, the function defaults to OFF).
- The ON/OFF button flashes when the effect is ON.

Parameter 1

Rotating the TIME (PARAMETER 1) dial adjusts the temporal parameter (time) for the selected effect.
See P. 19 for details regarding the effect on parameter 1 of rotating the TIME (PARAMETER 1) dial.

Parameter 2

Rotating the LEVEL/DEPTH (PARAMETER 2) dial adjusts the quantitative parameter for the selected effect.
See P. 19 for details regarding the effect on parameter 2 of rotating the LEVEL/DEPTH (PARAMETER 2) dial.

TYPE OF SOUND-COLOR EFFECT

1. HARMONIC

Detects deviation of the input sound from absolute pitch and automatically compensates to the nearest key.
By rotating the dial, the pitch/key can be adjusted within a range of ± 6 half-tones.

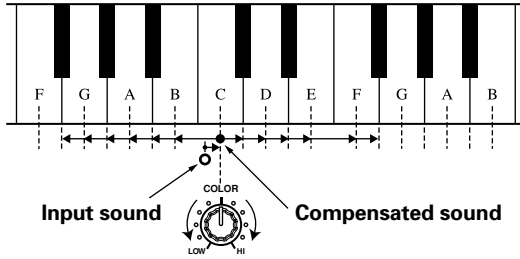

2. SWEEP

This function shifts the frequency of the filter, producing large changes in tone. When the dial is rotated clockwise, the effect produced is that of a band-pass filter, while rotating the dial counterclockwise produces the effect of a notch filter.

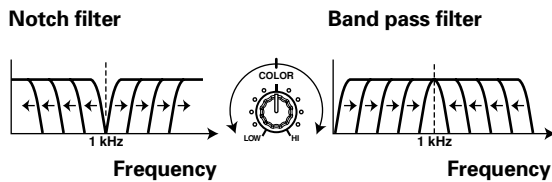

3. CRUSH

This effect slightly "crushes" the sound, applying a certain accent to the sound.

4. FILTER

The filter frequency is shifted, resulting in strong changes to the tone.
Rotating the dial to the right produces high-pass filter effects, while rotating the dial to the left produces low-pass filter effects.

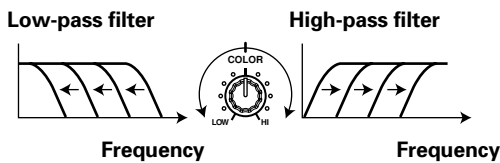

USING SOUND-COLOR EFFECTS

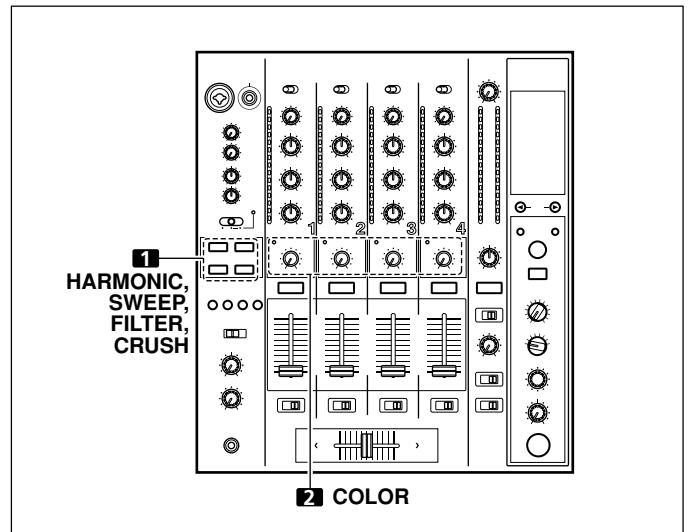

Sound-color effects are linked to the **COLOR** effect parameter dial for each channel.

* Sound-color effects are not applied to microphone inputs.

1. Press the sound-color effect selector buttons (HARMONIC, SWEEP, FILTER, CRUSH) for the desired effect.

HARMONIC:

Applies a pitch-shifted effect matching the track's key.

SWEEP:

The track is passed through the filter and output.

CRUSH:

The track's sound is output in a "crush" effect.

FILTER:

The track is filtered and output.

- The button for the selected effect will flash.
- The selected effect is applied equally to channels 1 to 4.
- If the flashing button is pressed, it lights steadily, and the effect turns OFF.
- When power is first turned on, all effects default to OFF (indicators are lighted).

2. Use the sound-color effect parameter dial (COLOR) to adjust the quantitative parameter for the effect.

- The parameter can be adjusted independently for each channel.
- The color of the harmonic indicator changes to indicate the condition of the harmonic effect.
Red: Deviation from frequency of key scale has been detected.
Green: Matches frequency of key scale.
Not lighted: Currently detecting deviation from frequency of key scale.

EFFECT PARAMETERS

Beat Effect (*1)

Name	Beat Switch Parameter	Parameter 1 (TIME dial)		Parameter 2 (MIX/DEPTH dial) contents
		Contents	Setting Range (unit)	
1 DELAY	Sets delay time of 1/8 to 16/1 per 1 beat of BPM time.	Sets delay time.	1 to 4 000 (ms)	Sets balance between original and delay sound.
2 ECHO (*2)	Sets delay time of 1/8 to 16/1 per 1 beat of BPM time.	Sets delay time.	1 to 4 000 (ms)	Sets balance between original sound and echo sound.
3 REVERSE DELAY	Sets delay time of 1/8 to 16/1 per 1 beat of BPM time.	Sets delay time.	10 to 4 000 (ms)	Sets balance between original and delay sound.
4 PAN	Sets time of 1/16 to 16/1 per 1 beat of BPM time for distribution to right/left.	Sets effect time.	10 to 16 000 (ms)	Sets balance between original sound and effect sound.
5 TRANS	Sets cut time of 1/16 to 16/1 per 1 beat of BPM time.	Sets effect time.	10 to 16 000 (ms)	Sets balance between original sound and effect sound.
6 FILTER	Cycle of cutoff frequency shift is set in unit of 1/4 to 64/1 relative to 1 beat of BPM.	Sets cycle for cutoff time shift.	10 to 32 000 (ms)	Amount of effect increases when dial is turned clockwise.
7 FLANGER	Cycle of flanger shift is set in units of 1/4 to 64/1 relative to 1 beat of BPM.	Sets cycle for flanger effect shift.	10 to 32 000 (ms)	Amount of effect increases when dial is turned clockwise. When dial is turned fully counterclockwise, only original sound is output.
8 PHASER	Cycle of phaser effect shift is set in units of 1/4 to 64/1 relative to 1 beat of BPM.	Sets cycle for phase effect shift.	10 to 32 000 (ms)	Amount of effect increases when dial is turned clockwise. When dial is turned fully counterclockwise, only original sound is output.
9 REVERB (*2)	Amount of reverberation is set from 1 to 100 %.	Sets amount of reverberation effect.	1 to 100 (%)	Sets balance between original sound and effect sound.
10 ROBOT	Sets pitch of robot sound effect within range of -100 to +100 %.	Sets pitch of robot sound effect.	-100 to +100 (%)	Amount of effect increases when dial is turned clockwise.
11 CHORUS	Cycle of chorus sound waver is set in units of 1/4 to 64/1 relative to 1 beat of BPM.	Sets cycle of chorus sound harmonic.	10 to 32 000 (ms)	Sets balance of chorus sound.
12 ROLL (*2)	Effect time is set as 1/16 to 16/1 relative of 1 beat of BPM.	Sets effect time.	1 to 4 000 (ms)	Sets balance of original sound and roll sound.
13 REVERSE ROLL (*2)	Effect time is set as 1/16 to 16/1 relative of 1 beat of BPM.	Sets effect time.	1 to 4 000 (ms)	Sets balance of original sound and roll sound.
14 SEND/RETURN	—	—	—	Sets volume of RETURN input sound.

(*1) When the effect channel selector is set to [CF.A], [CF.B], or [MASTER], even if the effect monitor is turned ON, if the selected channel's sound is not output to the master output, the effect sound will not be heard.

(*2) When effect is disabled (OFF), the effect sound will not be heard, even if monitor is set to effector.

Sound-color effects

Name	Parameter (COLOR dial)
1 HARMONIC	Sets amount of pitch shift in range of ± 6 half-tones. Rotating dial to right increases pitch shift by +6 half-tones, while rotating to the left reduces pitch shift by -6 half-tones.
2 SWEEP	Sets filter's cutoff frequency. Rotating dial clockwise produces band-pass filter effect; rotating counterclockwise produces notch filter effect.
3 CRUSH	Sets amount of crushing of input sound. Rotate dial counterclockwise to emphasize low-range sounds, and rotate clockwise to emphasize high-range sounds.
4 FILTER	Sets cutoff frequency of filter. Rotating dial to right changes high-pass filter; rotating dial to left changes low-pass filter.

MIDI SETTINGS

MIDI is an acronym for “Musical Instrument Digital Interface” and refers to a protocol developed for the exchange of data between electronic instruments and computers.

A MIDI cable is used to connect components equipped with MIDI connectors to enable the transmission and receipt of data.

The DJM-800 uses the MIDI protocol for transmitting and receiving data about component operation and BPM (timing clock).

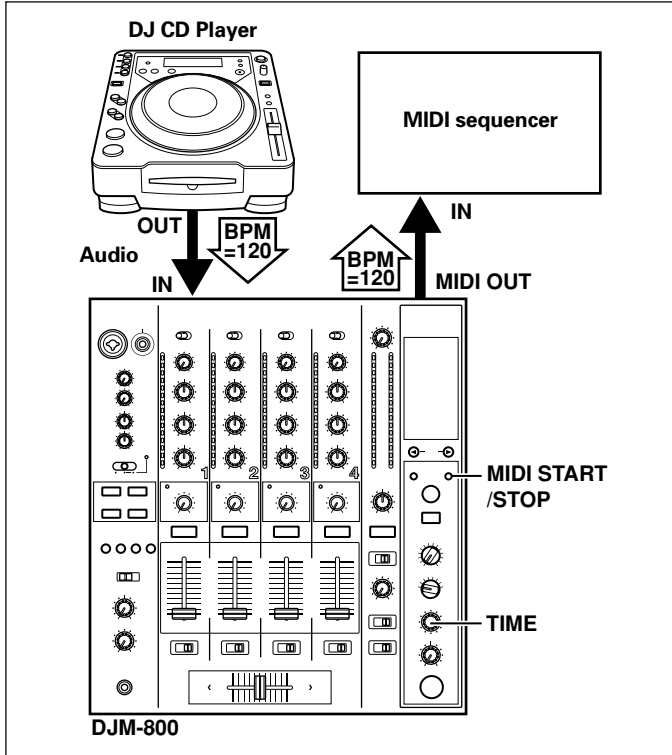

SYNCHRONIZING AUDIO SIGNALS TO EXTERNAL SEQUENCER, OR USING DJM-800 INFORMATION TO OPERATE AN EXTERNAL SEQUENCER

1. Use a commercially available MIDI cable to connect the DJM-800's MIDI OUT connector to the MIDI sequencer's MIDI IN connector.

- Set the MIDI sequencer's synch mode to "Slave".
- MIDI sequencers that do not support MIDI timing clock cannot be synchronized.
- Synch may not be achieved if the track's BPM cannot be detected and measured stably.
- BPM values set with the TAP mode can also be used to output the timing clock.

2. Press the MIDI START/STOP button.

- The MIDI timing clock output range is 40 to 250 BPM.

Note:

- Accurate measuring of BPM may be impossible with some tracks.

[MIDI Channel Setting]

The MIDI channel (1 to 16) can be set and stored in memory.

1. While holding the MIDI START/STOP button depressed, set the power switch to ON.

- The display will show [MIDI CH SETTING] and the unit will enter the MIDI setting mode.

2. Rotate the TIME dial to select the MIDI channel.

3. Press the MIDI START/STOP button.

- The selected MIDI channel will be recorded.

4. Set power to OFF.

MIDI MESSAGES

Category	Switch Name	Switch Type	MIDI Message						Comments
			MSB			LSB			
CH1	TRIM	VR	Bn	01	dd				0 to 127
	HI	VR	Bn	02	dd				0 to 127
	MID	VR	Bn	03	dd				0 to 127
	LOW	VR	Bn	04	dd				0 to 127
	COLOR	VR	Bn	05	dd				0 to 127
	CUE	BUTTON	Bn	46	dd				OFF=0, ON=127
	FADER	VR	Bn	11	dd				0 to 127
	CF ASSIGN	SW	Bn	41	dd				0, 64, 127
CH2	TRIM	VR	Bn	06	dd				0 to 127
	HI	VR	Bn	07	dd				0 to 127
	MID	VR	Bn	08	dd				0 to 127
	LOW	VR	Bn	09	dd				0 to 127
	COLOR	VR	Bn	0A	dd				0 to 127
	CUE	BUTTON	Bn	47	dd				OFF=0, ON=127
	FADER	VR	Bn	12	dd				0 to 127
	CF ASSIGN	SW	Bn	42	dd				0, 64, 127
CH3	TRIM	VR	Bn	0C	dd				0 to 127
	HI	VR	Bn	0E	dd				0 to 127
	MID	VR	Bn	0F	dd				0 to 127
	LOW	VR	Bn	15	dd				0 to 127
	COLOR	VR	Bn	16	dd				0 to 127
	CUE	BUTTON	Bn	48	dd				OFF=0, ON=127
	FADER	VR	Bn	13	dd				0 to 127
	CF ASSIGN	SW	Bn	43	dd				0, 64, 127

Category	Switch Name	Switch Type	MIDI Message						Comments
			MSB			LSB			
CH4	TRIM	VR	Bn	50	dd				0 to 127
	HI	VR	Bn	51	dd				0 to 127
	MID	VR	Bn	5C	dd				0 to 127
	LOW	VR	Bn	52	dd				0 to 127
	COLOR	VR	Bn	53	dd				0 to 127
	CUE	BUTTON	Bn	49	dd				OFF=0, ON=127
	FADER	VR	Bn	14	dd				0 to 127
	CF ASSIGN	SW	Bn	44	dd				0, 64, 127
CROSS FADER	CROSS FADER	VR	Bn	0B	dd				0 to 127
FADER CURVE	CH CURVE	SW	Bn	5E	dd				0, 64, 127
	CROSS CURVE	SW	Bn	5F	dd				0, 64, 127
MASTER	MASTER LEVEL	VR	Bn	18	dd				0 to 127
	BALANCE	VR	Bn	17	dd				0 to 127
	CUE	BUTTON	Bn	4A	dd				OFF=0, ON=127
BOOTH	MONITOR	VR	Bn	19	dd				0 to 127
EFFECT	BEAT LEFT	BUTTON	Bn	4C	dd				OFF=0, ON=127
	BEAT RIGHT	BUTTON	Bn	4D	dd				OFF=0, ON=127
	AUTO/TAP	BUTTON	Bn	45	dd				OFF=0, ON=127
	TAP	BUTTON	Bn	4E	dd				OFF=0, ON=127
	CUE	BUTTON	Bn	4B	dd				OFF=0, ON=127
	EFFECT SELECT	SW	Cn	pc					See "PROGRAM CHANGE" below.
	CH SELECT	SW	Cn	pc					
	TIME	SW	Bn	0D	MSB	Bn	2D	LSB	TIME value; FLANGER, PHASER, CHORUS, FILTER changed to 1/2 value; minus values are converted to positive.
	LEVEL/DEPTH	VR	Bn	5B	dd				0 to 127
EFFECT ON/OFF	BUTTON	Bn	40	dd				OFF=0, ON=127	
MIC	HI	VR	Bn	1E	dd				0 to 127
	LOW	VR	Bn	1F	dd				0 to 127
(SOUND COLOR FX)	HARMONIC	BUTTON	Bn	54	dd				OFF=0, ON=127
	SWEEP	BUTTON	Bn	55	dd				OFF=0, ON=127
	CRUSH	BUTTON	Bn	56	dd				OFF=0, ON=127
	FILTER	BUTTON	Bn	57	dd				OFF=0, ON=127
(FADER START)	1	BUTTON	Bn	58	dd				OFF=0, ON=127
	2	BUTTON	Bn	59	dd				OFF=0, ON=127
	3	BUTTON	Bn	5A	dd				OFF=0, ON=127
	4	BUTTON	Bn	5D	dd				OFF=0, ON=127
(HEAD PHONES)	MIXING	VR	Bn	1B	dd				0 to 127
	LEVEL	VR	Bn	1A	dd				0 to 127
MIDI	START	BUTTON	FA						
	STOP	BUTTON	FC						

PROGRAM CHANGE

MSB			LSB				
0	0	EFFSEL2	EFFSEL1	EFFSEL0	EFFCH2	EFFCH1	EFFCH0

• EFFECT SEL			BEAT
EFFSEL2	EFFSEL1	EFFSEL0	
0	0	1	DELAY
0	1	0	ECHO
—	—	—	REV DELAY
0	1	1	PAN
1	0	0	TRANS
1	1	0	FILTER
1	0	1	FLANGER
1	1	1	PHASER
—	—	—	REVERB
—	—	—	ROBOT
—	—	—	CHORUS
—	—	—	ROLL
—	—	—	REV ROLL
—	—	—	SND/RTN

• EFFECT SEL

EFFCH2	EFFCH1	EFFCH0	
0	0	1	1
0	1	0	2
0	1	1	3
1	0	0	4
1	0	1	MIC
1	1	0	CF.A
1	1	1	CF.B
—	—	—	MST

SNAPSHOT

Once the DJM-800 is setup with parameters for a given purpose, that set of parameters can be recorded as a snapshot. When snapshot of the current status is recorded, all messages for control change and program change are transmitted. Hold the **MIDI START/STOP** button depressed to send the snapshot.

TROUBLESHOOTING

Incorrect operations are often mistaken for trouble and malfunctions. If you think there is something wrong with this component, check the points below. Sometimes the trouble may originate from another component. Thus, also check the other electrical appliances also in use.

If the trouble cannot be rectified even after checking the following items, contact your dealer or nearest PIONEER service center.

Symptom	Possible Cause	Remedy
No power	<ul style="list-style-type: none"> The power cord has not been connected. 	<ul style="list-style-type: none"> Connect to power outlet.
No sound, or sound volume is too low.	<ul style="list-style-type: none"> Input selector is set incorrectly. The rear panel's DIGITAL/CD input selector switch or DIGITAL/LINE input selector switch is set incorrectly. Connection cables are connected incorrectly, or connections are loose. Jacks or plugs are dirty. The rear panel master output attenuator switch (MASTER ATT) is set to -12 dB, etc. 	<ul style="list-style-type: none"> Set input selector to playback component. Set the rear panel's DIGITAL/CD input selector switch or DIGITAL/LINE input selector switch to match the component being played. Connect correctly. Clean soiled jacks/plugs before connecting. Adjust rear panel master attenuator switch (MASTER ATT).
Microphone sound isn't produced in BOOTH output.	<ul style="list-style-type: none"> The rear panel's MIC SIGNAL switch is set to [CUT]. 	<ul style="list-style-type: none"> Set rear panel's MIC SIGNAL switch to [ADD].
No digital output.	<ul style="list-style-type: none"> The digital output sampling frequency (fs) does not match the specifications of the connected component. 	<ul style="list-style-type: none"> Set rear panel sampling frequency selector to match the specifications of the connected component.
Sound is distorted.	<ul style="list-style-type: none"> Master output level is too high. Input level is too high. 	<ul style="list-style-type: none"> Adjust master output level (MASTER LEVEL) dial or the rear panel master output attenuator (MASTER ATT) switch. Adjust the TRIM dial so that the input level approaches 0 dB on the channel level indicator.
Cross fader doesn't work.	<ul style="list-style-type: none"> CROSS FADER ASSIGN switch setting ([A], [THRU], [B]) is incorrect. 	<ul style="list-style-type: none"> Correctly set the CROSS FADER ASSIGN switch for the desired channel.
Can't perform fader start with CD player.	<ul style="list-style-type: none"> The FADER START button is set to OFF. Rear panel CONTROL jack is not connected to CD player. Only the rear panel CONTROL jack is connected to the CD player. 	<ul style="list-style-type: none"> Set the FADER START button to ON. Use a control cable to connect the CONTROL jacks of mixer and CD player. Connect both the CONTROL jacks and analog input connectors.
Effects don't work.	<ul style="list-style-type: none"> Effect channel selector setting is incorrect. Effect parameter 2 adjust dial (LEVEL/DEPTH) is set to [MIN]. 	<ul style="list-style-type: none"> Correctly select the channel on which you wish to apply effects. Adjust the effect parameter 2 adjust dial (LEVEL/DEPTH).
External effector doesn't work.	<ul style="list-style-type: none"> Effect selector is not set to [SND/RTN]. Effector is not connected to rear panel SEND/RETURN connector. Effect channel selector is set to incorrectly. 	<ul style="list-style-type: none"> Set effect selector to [SND/RTN]. Connect effector to the rear panel SEND/RETURN connectors. Use the effect channel selector to select the audio source to which you wish to apply the effects.
Sound from external effector is distorted.	<ul style="list-style-type: none"> Input level from external effector is set too high. 	<ul style="list-style-type: none"> Lower the output level of the external effector.
BPM can't be measured. Measured BPM value is incorrect.	<ul style="list-style-type: none"> Input level is too high, or too low. BPM may not be correctly measurable with some tracks. 	<ul style="list-style-type: none"> Adjust the TRIM dial so that the input level approaches 0 dB in the channel level indicator. Adjust other channels as well so that the input levels approach 0 dB in the channel level indicator. Strike the TAP button to set BPM manually.
The measured BPM value is different from the value published with the CD.	<ul style="list-style-type: none"> Some differences may occur due to differences in BPM detection methods. 	<ul style="list-style-type: none"> No remedy is necessary.
MIDI sequencer can't be synchronized.	<ul style="list-style-type: none"> MIDI sequencer's synch mode is not set to "slave". MIDI sequencer is not supported type. 	<ul style="list-style-type: none"> Set MIDI sequencer's sync mode to "slave". MIDI sequencers that do not support MIDI timing lock cannot be synchronized.

Static electricity or other external interference may cause the unit to malfunction. To restore normal operation, turn the power off and then on again.

SPECIFICATIONS

1. General

Power source	AC 120 V, 60 Hz
Power consumption	32 W
Operating temperature	+5 °C to +35 °C (+41 °F to +95 °F)
Operating humidity	5 % to 85 % (without condensation)
Weight	8.0 kg (17.64 lb)
Maximum dimensions	320 (W) × 381 (D) × 108 (H) mm 12-5/8 (W) × 15 (D) × 4-1/4 (H) in

2. Audio section

Sampling rate	96 kHz
A/D, D/A converter	24 bits
Frequency response	
LINE	20 Hz to 20 kHz
MIC	20 Hz to 20 kHz
PHONO	20 Hz to 20 kHz (RIAA)
S/N ratio (at rated output)	
LINE	105 dB
PHONO	88 dB
MIC	84 dB
Distortion (LINE-MASTER 1)	0.005 %
Standard input level/Input impedance	
PHONO 2 to 4	-52 dBu/47 kΩ
MIC 1, MIC 2	-52 dBu/3 kΩ
LINE, LINE/CD 1 to 4	-12 dBu/22 kΩ
RETURN	-12 dBu/22 kΩ
Standard output level/Load impedance/Output impedance	
MASTER 1	+2 dBu/10 kΩ/10 Ω or less
MASTER 2	+2 dBu/10 kΩ/1 kΩ
REC	-8 dBu/10 kΩ/1 kΩ
BOOTH	+2 dBu/600 Ω/600 Ω
SEND	-12 dBu/10 kΩ/1 kΩ
PHONES	+8.5 dBu/32 Ω/22 Ω or less
Rated output level/Load impedance	
MASTER 1	+22 dBu/10 kΩ
MASTER 2	+20 dBu/10 kΩ
Crosstalk (LINE)	82 dB
Channel equalizer response	
HI	-26 dB to +6 dB (13 kHz)
MID	-26 dB to +6 dB (1 kHz)
LOW	-26 dB to +6 dB (70 Hz)
Microphone equalizer response	
HI	-12 dB to +6 dB (10 kHz)
LOW	-12 dB to +6 dB (100 Hz)

3. Input/output connector systems

PHONO input connectors	
RCA pin jacks	3
LINE/CD input connectors	
RCA pin jacks	4
LINE input connectors	
RCA pin jacks	1
MIC input connectors	
XLR connector/phone jack (Ø6.3 mm)	1
Phone jack (Ø6.3 mm)	1
DIGITAL coaxial input connectors	
RCA pin jacks	4
RETURN input connectors	
Phone jacks (Ø6.3 mm)	1
MASTER output connectors	
XLR connectors	1
RCA pin jacks	1
BOOTH output connectors	
Phone jacks (Ø6.3 mm)	1
REC output connectors	
RCA pin jacks	1
SEND output connectors	
Phone jacks (Ø6.3 mm)	1
DIGITAL coaxial output connector	
RCA pin jack	1
MIDI OUT connector	
5P DIN	1
PHONES output connector	
Stereo phone jack (Ø6.3 mm)	1
CONTROL connector	
Mini phone jacks (Ø3.5 mm)	4

4. Accessories

Operating Instructions	1
Power cord	1
Warranty card	1

Specifications and appearance are subject to change without notice.

Should this product require service in the U.S.A. and you wish to locate the nearest Pioneer Authorized Independent Service Company, or if you wish to purchase replacement parts, operating instructions, service manuals, or accessories, please call the number shown below.

800 – 782 – 7210

Please do not ship your product to Pioneer without first calling the Customer Support Division at the above listed number for assistance.

**PIONEER ELECTRONICS (USA), INC.
CUSTOMER SUPPORT DIVISION
P.O. BOX 1760, LONG BEACH,
CA 90801-1760, U.S.A.**

For warranty information please see the Limited Warranty sheet included with your product.

Should this product require service in Canada, please contact a Pioneer Canadian Authorized Dealer to locate the nearest Pioneer Authorized Service Company in Canada.

Alternatively, please contact the Customer Service Department at the following address:

Pioneer Electronics of Canada, Inc.

**300 Allstate Parkway
Markham, ON L3R 0P2
(905) 479-4411
1 (877) 283-5901**

For warranty information please see the Limited Warranty sheet included with your product.

BLOCK DIAGRAM

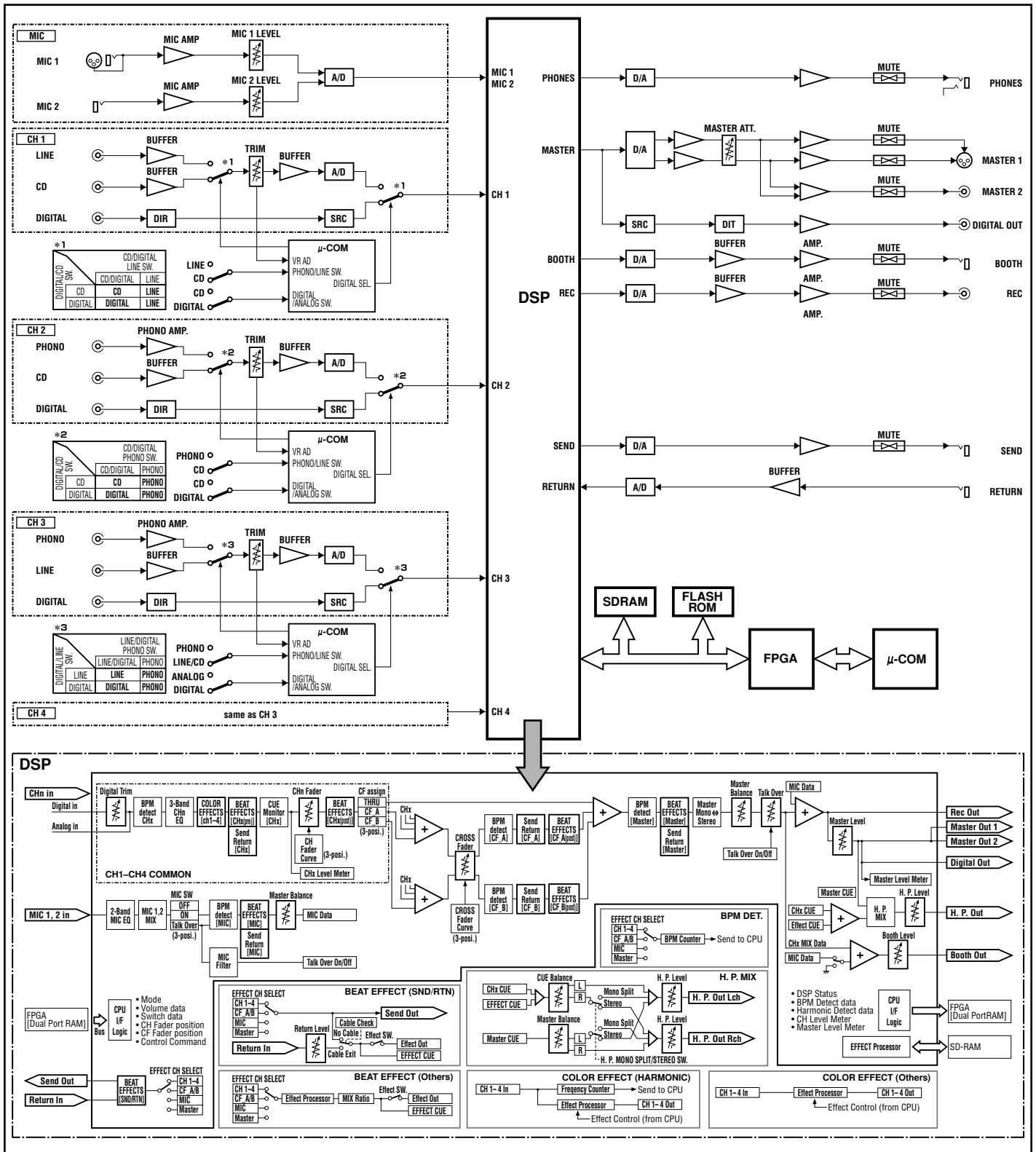

Published by Pioneer Corporation.
 Copyright © 2005 Pioneer Corporation.
 All rights reserved.