

J

J-INFRA
Manual 2.1 en

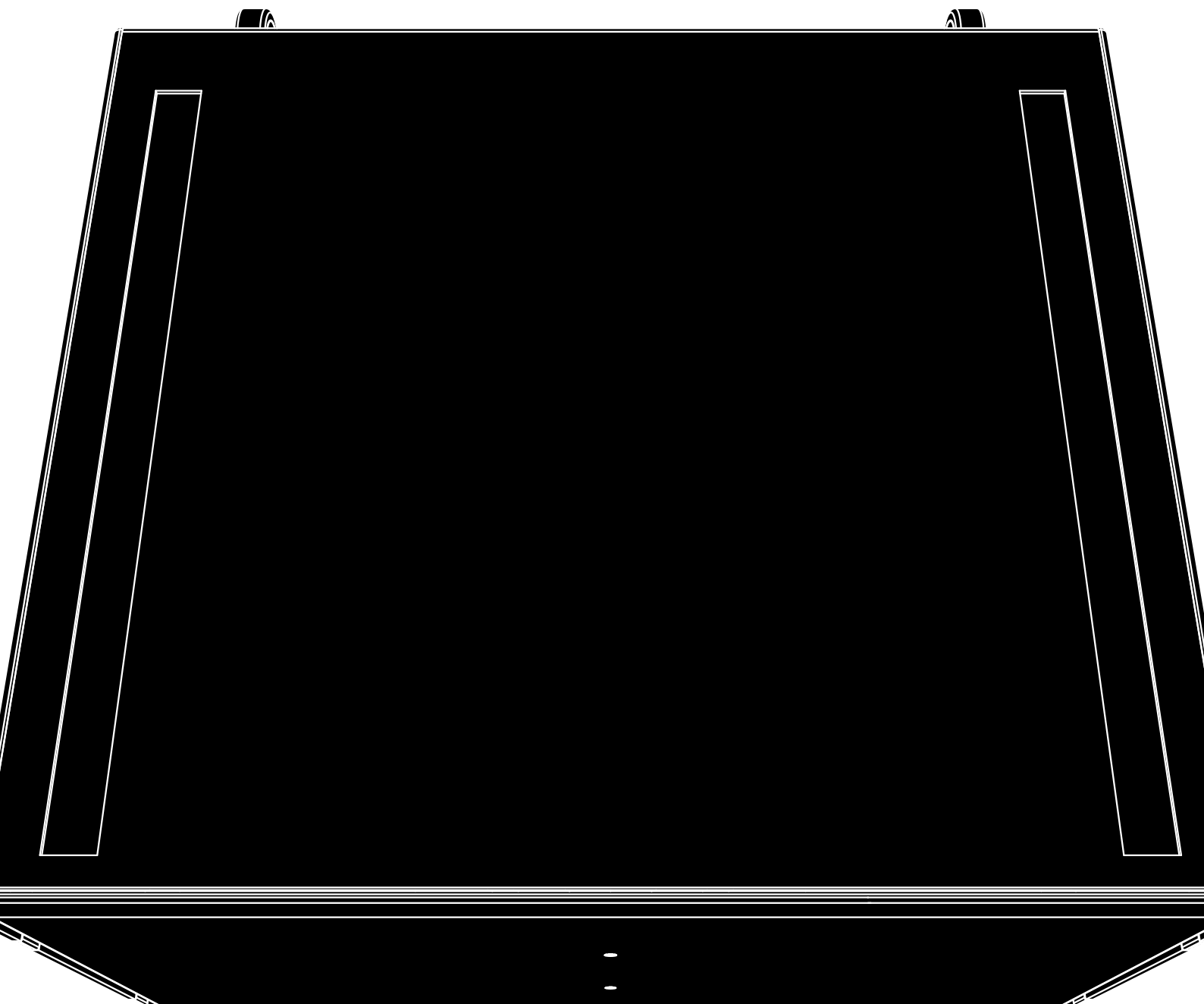

General information

J-INFRA Manual

Version: 2.1 en, 08/2015, D2984.EN .02

Copyright © 2015 by d&b audiotechnik GmbH; all rights reserved.

Keep this manual with the product or in a safe place so that it is available for future reference.

When reselling this product, hand over this manual to the new owner.

If you supply d&b products, please draw the attention of your customers to this manual. Enclose the relevant manuals with the systems. If you require additional manuals for this purpose, you can order them from d&b.

d&b audiotechnik GmbH
Eugen-Adolff-Strasse 134, D-71522 Backnang, Germany
T +49-7191-9669-0, F +49-7191-95 00 00
docadmin@dbaudio.com, www.dbaudio.com

1. Safety precautions	4
1.1. Information regarding the use of loudspeakers.....	4
2. J-INFRA loudspeaker	5
2.1. Product description.....	5
2.2. Connections.....	6
2.3. Operation.....	6
2.3.1. Controller settings.....	7
2.4. Technical specifications.....	8
3. Manufacturer's declarations	9
3.1. EU conformity of loudspeakers (CE symbol).....	9
3.1.1. WEEE Declaration (Disposal).....	9

1.1. Information regarding the use of loudspeakers

Potential risk of personal injury

Never stand in the immediate vicinity of loudspeakers driven at a high level. Professional loudspeaker systems are capable of causing a sound pressure level detrimental to human health. Seemingly non-critical sound levels (from approx. 95 dB SPL) can cause hearing damage if people are exposed to it over a long period.

In order to prevent accidents when deploying loudspeakers on the ground or when flown, please take note of the following:

- When setting up the loudspeakers or loudspeaker stands, make sure they are standing on a firm surface. If you place several systems on top of one another, use straps to secure them against movement.
- Only use accessories which have been tested and approved by d&b for assembly and mobile deployment. Pay attention to the correct application and maximum load capacity of the accessories as detailed in our specific "Mounting instructions" or in our "Flying system and Rigging manuals".
- Ensure that all additional hardware, fixings and fasteners used for installation or mobile deployment are of an appropriate size and load safety factor. Pay attention to the manufacturers' instructions and to the relevant safety guidelines.
- Regularly check the loudspeaker housings and accessories for visible signs of wear and tear, and replace them when necessary.
- Regularly check all load bearing bolts in the mounting devices.

Potential risk of material damage

Loudspeakers produce a static magnetic field even if they are not connected or are not in use. Therefore make sure when erecting and transporting loudspeakers that they are nowhere near equipment and objects which may be impaired or damaged by an external magnetic field. Generally speaking, a distance of 0.5 m (1.5 ft) from magnetic data carriers (floppy disks, audio and video tapes, bank cards, etc.) is sufficient; a distance of more than 1 m (3 ft) may be necessary with computer and video monitors.

2. J-INFRA loudspeaker

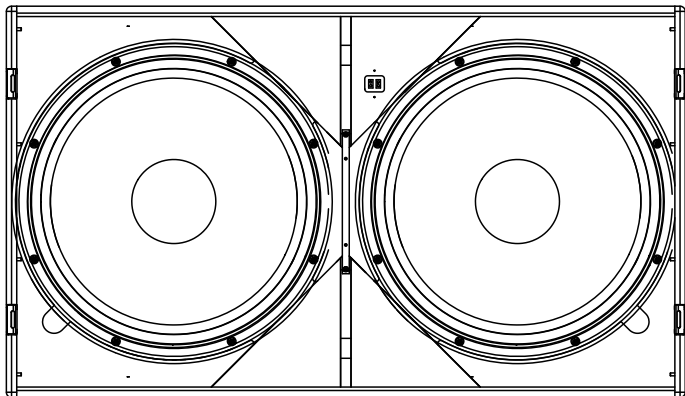

2.1. Product description

The J-INFRA is the cardioid infra subwoofer for the J-Series. It can be used to supplement J-Series systems consisting of J8, J12 and J-SUB cabinets in various combinations. It extends the frequency response of a J-Series system down to 27 Hz

J-INFRA cabinets can be used ground stacked in a conventional L/R setup as well as arranged in a subwoofer array. One J-INFRA cabinet provides additional very low frequency energy for two J-SUBs.

The J-INFRA cabinet is an actively driven 2-way bass-reflex design housing three long excursion neodymium 21" drivers, two drivers face to the front while one driver radiates to the rear of the cabinet.

Front and rear drivers are driven by separate amplifier channels and operate in independent bass reflex chambers. Through its cardioid dispersion pattern this setup avoids unwanted energy behind the system and greatly reduces the reverberant field at low frequencies providing highest accuracy in low frequency reproduction. J-INFRA cabinets have to be arrayed with a minimum distance of 60 cm (2 ft) between adjacent cabinets.

The cabinet is constructed from marine plywood and has an impact and weather protected PCP (Polyurea Cabinet Protection) finish. The front and rear of the loudspeaker cabinet are protected by a rigid metal grill. Each side panel incorporates four handles and mounted on the rear panel are four heavy duty wheels. Two runners extend from the rear to the front panel of the cabinet protecting the bottom panel against scratching. Two correspondingly shaped recesses are incorporated in the top panel of each cabinet to accept these runners and prevent cabinet movement when stacking J-INFRA's. The cabinet front is fitted with four catches for securing the optional transport lid E7920.

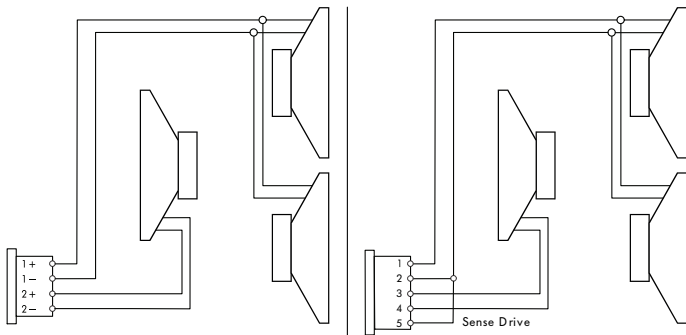

NLT4 F and EP5 connector wiring

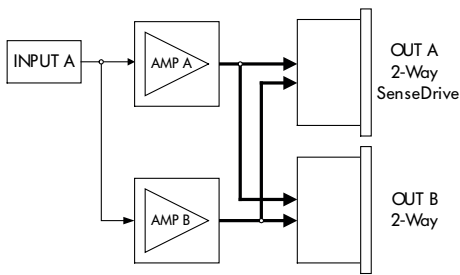

D12 Input/Output routing 2-Way Active mode

2.2. Connections

The cabinet is fitted with a single NLT4 F connector. It uses the pin assignments 1+/1- for the front drivers. Pins 2+/2- drive the rear driver.

The cabinets can be supplied with EP5 or NL8 connectors as an option.

Pin equivalents of the connector options are listed in the table below.

	LF + Front	LF - Front	LF + Rear	LF - Rear	SenseDrive (SD)
NLT4 F	1+	1-	2+	2-	n.a.
EP5	1	2	3	4	5
NL8	1+	1-	4+	4-	3-

d&b SenseDrive

The SenseDrive feature within D12 amplifiers enables electrical compensation for the properties of the loudspeaker cable used. SenseDrive requires an additional sense wire. SenseDrive is therefore only available with EP5 connectors and 5-wire cabling for applicable loudspeakers.

Note: To enable SenseDrive for the front drivers the loudspeaker cabinet has to be connected to output A.

d&b LoadMatch

Starting with the D80 amplifier platform, the LoadMatch function enables the amplifier to electrically compensate for the properties of the loudspeaker cable used without the need for an additional sense wire. For applicable loudspeakers, LoadMatch is therefore independent of the connector type used.

2.3. Operation

NOTICE!

Only operate d&b loudspeakers with a correctly configured d&b amplifier, otherwise there is a risk of damaging the loudspeaker components.

Application	Setup	Cabinets per pair of amplifier channels
J-INFRA	J-INFRA	1

For applicable d&b amplifiers, the controller setup is available in 2-Way Active mode. Each pair of amplifier output channels drives a single J-INFRA cabinet.

The two channels are tuned to create a cardioid dispersion pattern thus providing maximum rejection to the rear.

2.3.1. Controller settings

When J-INFRA cabinets are placed close to J-SUB cabinets the standard mode is selected.

For acoustic adjustment the 70 Hz and HCD function can be selected.

70 circuit

When J-INFRA cabinets are located remotely from J-SUB cabinets there is less coupling between the systems. Selecting the 70 Hz circuit compensates for this effect by extending the upper frequency limit to 70 Hz.

HCD circuit

Selecting HCD (Hypercardioid) optimizes the tuning of front and rear channels for a maximum rejection at the left and right sides behind the cabinet providing a hypercardioid dispersion pattern. This characteristic is particularly useful for a setup with subwoofers stacked at the left and right sides of a stage providing minimum interference onstage.

HCD mode can be used either freely radiating or in front of walls. The minimum distance to rear walls is provided by the wheels on the cabinet back. Even in HCD mode adjacent columns of J-SUBs have to be at least 60 cm (2 ft) apart.

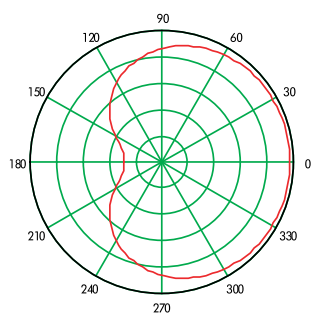

Cardioid polar pattern

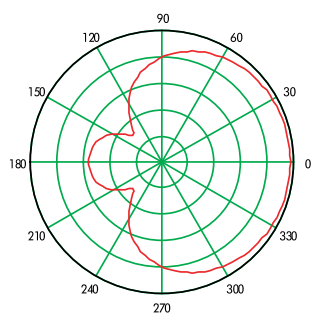

Hypercardioid polar pattern

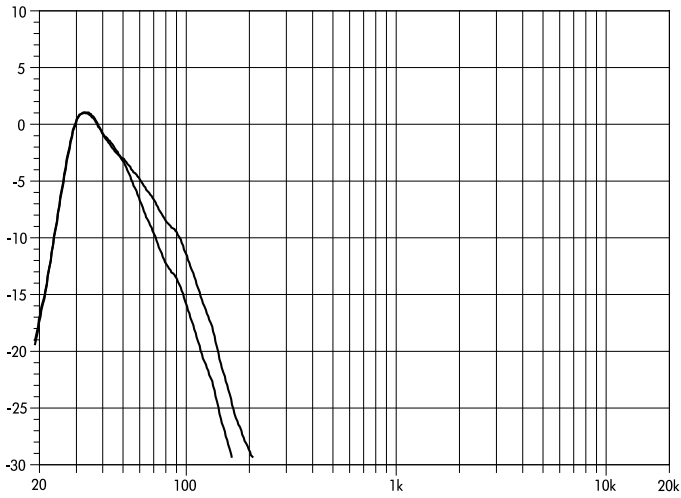

J-INFRA frequency response, standard and 70 Hz mode

2.4. Technical specifications

J-INFRA system data

Frequency response (-5 dB standard)	27 Hz - 60 Hz
Frequency response (-5 dB 70 Hz mode)	27 Hz - 70 Hz
Max. sound pressure (1 m, free field)
with D12/30D	141 dB
with D80	144 dB
.....(SPLmax peak, pink noise test signal with crest factor of 4)	

J-INFRA loudspeaker

Nominal impedance Front/Rear	3/6 ohms
Power handling capacity Front (RMS/peak 10 ms)	1200/4800 W
Power handling capacity Rear (RMS/peak 10 ms)	600/1200 W
Components	3 x 21" driver
Connections	1 x NLT4 F
.....	optional 1 x EP5 or NL8
Pin assignment
.....	NLT4 F/M: 1+: Front+/ 1 -: Front- / 2+: Rear+/ 2 -: Rear-
.....	EP5: 1: Front+/2: Front-/ 3: Rear+/4: Rear-/ 5: SD Front
.....	NL8: 1+: Front+/1 -: Front-/ 4+: Rear+/4 -: Rear-/ 3 -: SD Front
Weight	152 kg (335 lb)

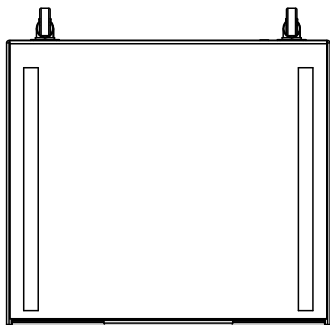
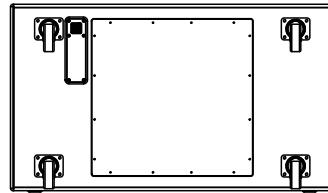
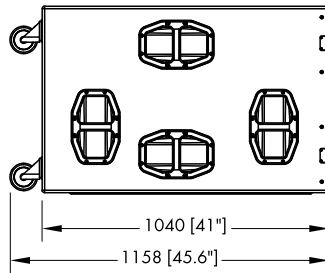
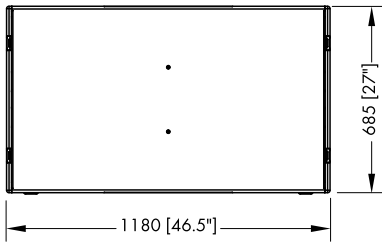

J-INFRA cabinet dimensions in mm [inch]



3.1. EU conformity of loudspeakers (CE symbol)

This declaration applies to:

d&b J-INFRA loudspeaker, Z1000

manufactured by d&b audiotechnik GmbH.

All production versions of these types are included, provided they correspond to the original technical version and have not been subject to any later design or electromechanical modifications.

We herewith declare that said products are in conformity with the provisions of the respective EC directives including all applicable amendments.

A detailed declaration is available on request and can be ordered from d&b or downloaded from the d&b website at www.dbaudio.com.

3.1.1. WEEE Declaration (Disposal)

Electrical and electronic equipment must be disposed of separately from normal waste at the end of its operational lifetime.

Please dispose of this product according to the respective national regulations or contractual agreements. If there are any further questions concerning the disposal of this product, please contact d&b audiotechnik.

