

# Y

**Yi8/Yi12**  
**Manual 1.1 en**

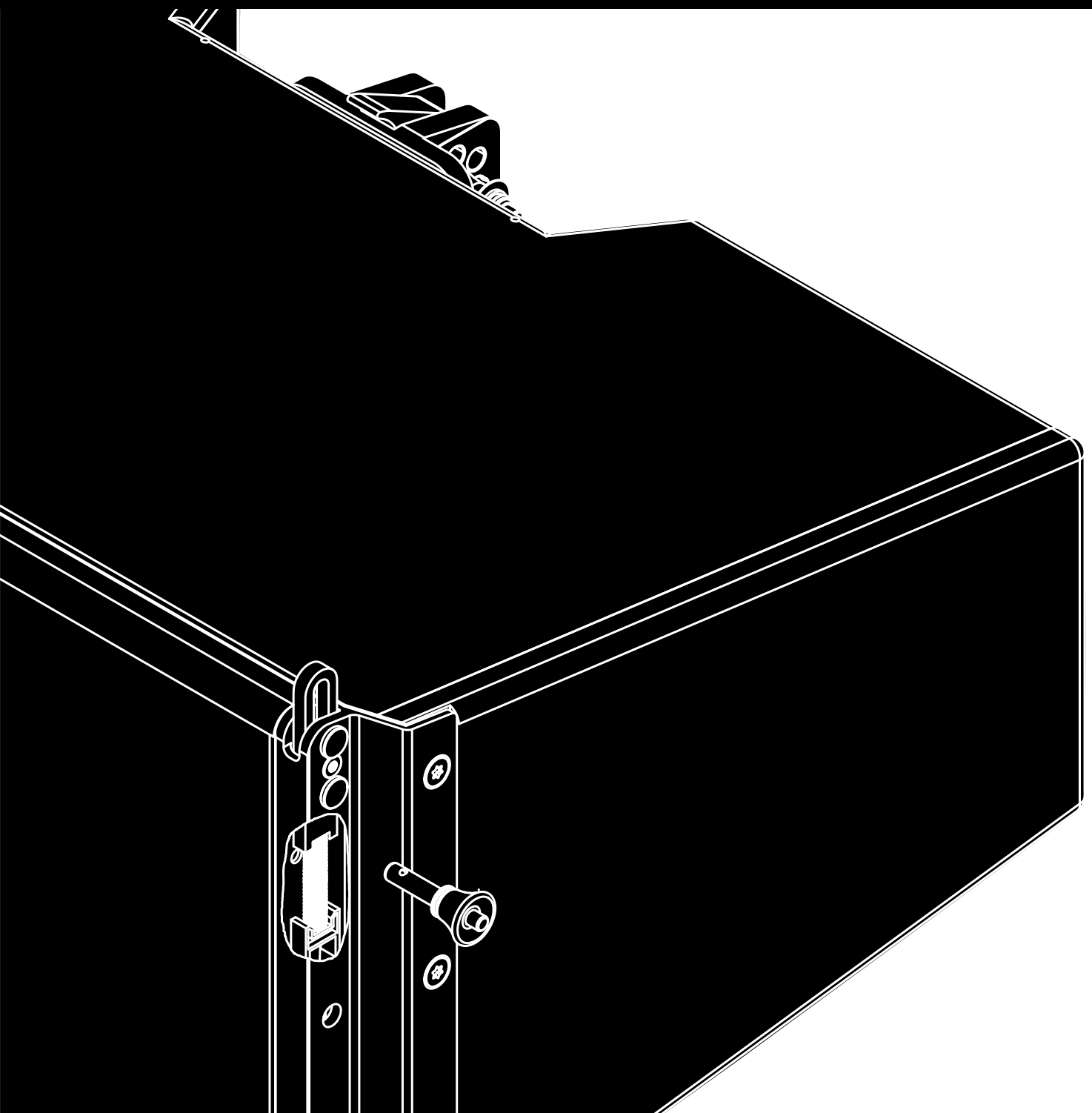

## **General information**

Yi8/Yi12 Manual

Version: 1.1 en, 08/2014, D2712.EN .01

Copyright © 2014 by d&b audiotechnik GmbH; all rights reserved.

**Keep this manual with the product or in a safe place so that it is available for future reference.**

When reselling this product, hand over this manual to the new customer.

If you supply d&b products, please draw the attention of your customers to this manual. Enclose the relevant manuals with the systems. If you require additional manuals for this purpose, you can order them from d&b.

d&b audiotechnik GmbH  
Eugen-Adolff-Strasse 134, D-71522 Backnang, Germany  
T +49-7191-9669-0, F +49-7191-95 00 00  
docadmin@dbaudio.com, www.dbaudio.com

<b>1. Safety precautions.....</b>	<b>4</b>
1.1. Information regarding the use of loudspeakers.....	4
<b>2. Yi8/Yi12 loudspeaker.....</b>	<b>5</b>
2.1. Product description.....	5
2.2. Connections.....	6
2.3. Operation.....	7
2.3.1. Controller settings.....	8
2.4. Dispersion characteristics.....	9
2.5. Technical specifications.....	9
<b>3. Manufacturer's declarations.....</b>	<b>11</b>
3.1. EU conformity of loudspeakers (CE symbol).....	11
3.1.1. WEEE Declaration (Disposal).....	11

## 1.1. Information regarding the use of loudspeakers

### Potential risk of personal injury

Never stand in the immediate vicinity of loudspeakers driven at a high level. Professional loudspeaker systems are capable of causing a sound pressure level detrimental to human health. Seemingly non-critical sound levels (from approx. 95 dB SPL) can cause hearing damage if people are exposed to it over a long period.

In order to prevent accidents when deploying loudspeakers on the ground or when flown, please take note of the following:

- When setting up the loudspeakers or loudspeaker stands, make sure they are standing on a firm surface. If you place several systems on top of one another, use straps to secure them against movement.
- Only use accessories which have been tested and approved by d&b for assembly and mobile deployment. Pay attention to the correct application and maximum load capacity of the accessories as detailed in our specific "Mounting instructions" or in our "Flying system and Rigging manuals".
- Ensure that all additional hardware, fixings and fasteners used for installation or mobile deployment are of an appropriate size and load safety factor. Pay attention to the manufacturers' instructions and to the relevant safety guidelines.
- Regularly check the loudspeaker housings and accessories for visible signs of wear and tear, and replace them when necessary.
- Regularly check all load bearing bolts in the mounting devices.

### Potential risk of material damage

Loudspeakers produce a static magnetic field even if they are not connected or are not in use. Therefore make sure when erecting and transporting loudspeakers that they are nowhere near equipment and objects which may be impaired or damaged by an external magnetic field. Generally speaking, a distance of 0.5 m (1.5 ft) from magnetic data carriers (floppy disks, audio and video tapes, bank cards, etc.) is sufficient; a distance of more than 1 m (3 ft) may be necessary with computer and video monitors.

## 2. Yi8/Yi12 loudspeaker

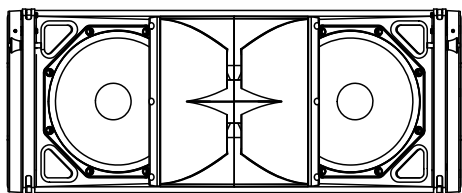

### 2.1. Product description

The Yi8 line array module is intended for small to medium sound reinforcement application. When the Y Flying frame is used, up to 24 cabinets can be flown in vertical columns producing a constant directivity dispersion pattern of 80° in the horizontal plane.

The Yi12 line array module is acoustically and mechanically compatible with the Yi8 providing a 120° horizontal dispersion.

The Yi8/Yi12 cabinets are passive 2-way designs, both housing 2 x 8" neodymium LF drivers, one 1.4" exit HF compression driver with a 3" diaphragm mounted to a dedicated wave shaping device and a passive crossover network.

The wave segments of each cabinet couple without gaps and sum up coherently. Splay angles between adjacent cabinets can be set in the range from 0° to 14° with a 1° resolution.

The two LF drivers are positioned in a dipolar arrangement providing an exceptional dispersion control even at lower frequencies with the nominal horizontal dispersion angle being maintained down to 500 Hz.

The frequency response extends from 54 Hz to above 19 kHz.

The cabinets are constructed from marine plywood and have an impact and weather protected PCP (Polyurea Cabinet Protection) finish. The fronts of the loudspeaker cabinets are protected by a rigid metal grill backed by an acoustically transparent foam.

### Yi-Series rigging components and arrays

Yi-Series arrays may consist of a combination of Yi8 and Yi12 loudspeakers and/or Yi-SUB cardioid subwoofers.

Cabinets are mechanically connected using the rigging strands on both sides of the cabinet front and a central strand at the rear of the cabinet. All necessary rigging components are mounted to the cabinet and fold out or slide out when needed.

A detailed description of the Yi-Series rigging components is given in the Yi-Series Rigging manual which is provided with the Y Flying frame.

A detailed description of planning and designing Yi arrays is given in the technical information "TI 385 d&b Line array design, d&b ArrayCalc" which is also provided with the Y Flying frame.

The d&b ArrayCalc simulation software can be downloaded from the d&b website at [www.dbaudio.com](http://www.dbaudio.com).

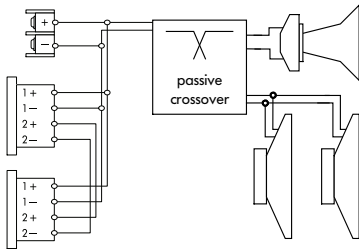

**Connector wiring**

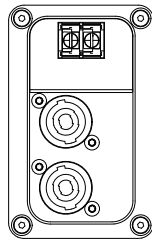

## 2.2. Connections

The cabinets are fitted with a pair of NL4 connectors and a two pole screw terminal block (ST). All four pins of both NL4 connectors are wired in parallel. The cabinets use the pin assignments 1+/1-. Pins 2+/2- are designated to active subwoofers.

Cabinets with the weather resistant option (WR) are equipped with a fixed input cable (PG type, H07-RN-F, 2 x 2.5 mm<sup>2</sup> (AWG 13), standard length 5.5 m (18 ft).

Pin equivalents of the applicable connector options are listed in the table below.

NL4	1+	1-	2+	2-
ST	+	-	n.a.	n.a.
PG	Brown (+)	Blue (-)	n.a.	n.a.

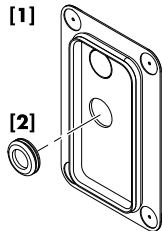

**Cover plate and rubber grommet**

### Fixed cable connection

The Yi8 and Yi12 loudspeakers are each supplied with a cover plate [1] and a rubber grommet feed through [2]. For indoor operation, these items can be used to hide the connector panel, if required. For unprotected outdoor operation, the connector panel must be covered, i.e. both items must be used to achieve an IP degree of protection of IP34.

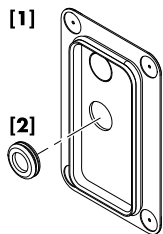

**Step 1**

To install the fixed cable connection, proceed as follows:

**Tools required:** Philips screw driver (#PH2).

1. Remove the knockout opening in the cover plate [1] and attach the rubber grommet [2] correspondingly.
2. Insert the connection cable through the rubber grommet.
3. Undo the four screws of the connector panel.
4. Connect the cable wires to the screw terminal.  
⇒ Observe the correct polarity!
5. Push the cover plate towards the connector panel until it fits into place.
6. Finally fix the cover plate together with the connector panel using all screws.

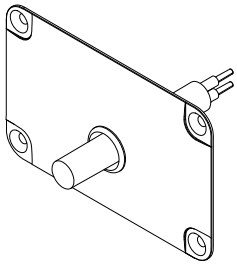

**Step 2**

**Installing the fixed cable connection**

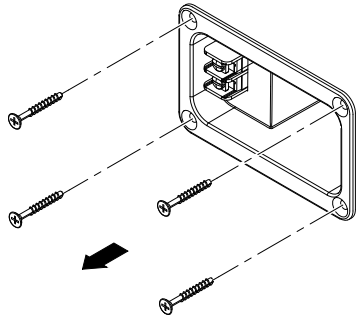

**Step 3**

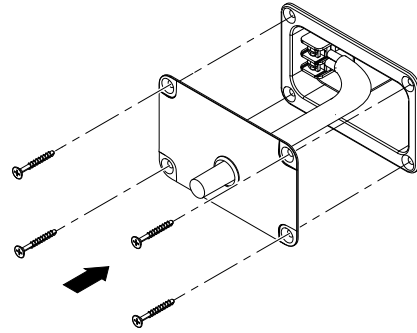

**Step 4/5**

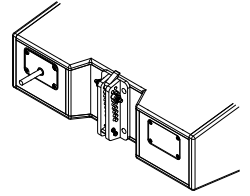

**Step 6**

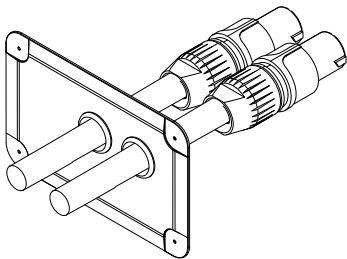

**NL4 cable connection with cover plate [1]**

**NL4 connection with cover plate**

The two NL4 connector sockets of the cabinet's connector panel are located in a recess to allow the use of the cover plate [1] together with NL4 cable connectors, as shown in the graphic opposite.

**Note:** Neutrik NL4FC type connectors must be used for this option.

The cover plate is equipped with two knockout openings to allow daisy chaining of the loudspeaker. To use the NL4 connection, proceed in the same manner as described in the previous section .

**2.3. Operation**

**NOTICE!**

Only operate d&b loudspeakers with a correctly configured d&b amplifier, otherwise there is a risk of damaging the loudspeaker components.

The applicable amplifiers provide two setups ("Arc" or "Line") for the Yi8 and Yi12 loudspeakers. These are available in Dual Channel or Mix TOP/SUB mode.

Selecting the respective Y8 or Y12 setup enables up to two Yi8 or Yi12 cabinets to be driven by the respective amplifier channel.

**Arc and Line setups**

The selection of Arc or Line depends on the curvature of the array. Both setups may be used within one array.

The Arc setup is intended for line array loudspeakers when used in curved array sections.

The Line setup is used for long throw array sections with three or more consecutive splay settings of 0°, 1° or 2°. Compared to the Arc setup, the mid/high range is reduced to compensate for the extended nearfield.

The transition from Line to Arc configuration within the array is made according to the splay progression but may allow for certain deviations due to the wiring of the cabinets in groups of up to two.

### 2.3.1. Controller settings

For acoustic adjustment the functions CUT, CPL and HFC can be selected.

#### CUT circuit

Set to CUT, the low frequency level of the cabinets is reduced. The Yi8/Yi12 array is now configured for use with the d&b Yi-SUB or J-SUB subwoofers.

#### CPL circuit

The CPL (Coupling) circuit compensates for coupling effects between the cabinets of an array. CPL begins gradually around 2 kHz, with the maximum attenuation below 100 Hz. As coupling effects increase with the length of the line array, the CPL circuit can be set to dB attenuation values between 0 and -9. With higher attenuation values the corner frequency of the filter shifts towards lower values.

Positive CPL values create an adjustable low frequency boost (0 to +5 dB) and can be set when the system is used in full range mode without subwoofers.

**Note:** Make sure that all cabinets within the line array are operated with the same CPL setting.

#### HFC circuit

Selecting the HFC (High Frequency Compensation) circuit compensates for the loss of high frequency energy due to air absorption when loudspeakers are used to cover far field listening positions.

The HFC circuit has two settings (HFC1 and HFC2) for different distances the cabinets need to cover. The settings should be used selectively; HFC1 for cabinets covering distances larger than 25 m (82 ft) and HFC2 for those covering distances larger than 50 m (164 ft).

The compensation is adjusted for a typical relative humidity of 40%. With lower humidity the absorption by air increases therefore the distances where the respective HFC setting provides a correct equalization are shorter than indicated above.

Using the HFC function provides the correct sound balance between close and remote audience areas, whilst all amplifiers driving the array can be fed with the same signal.

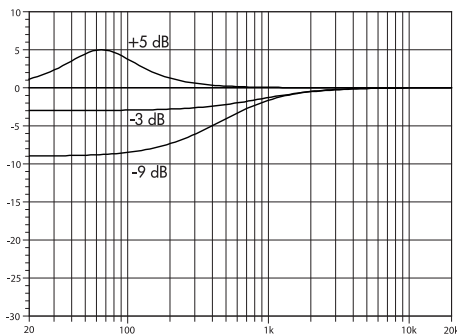

Frequency response correction of CPL circuit

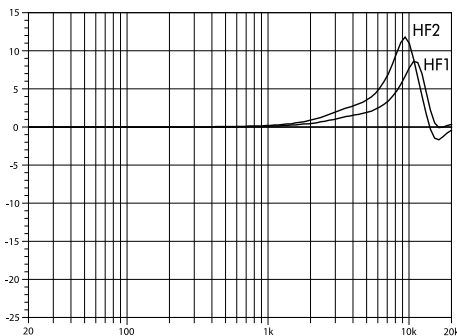

Frequency response correction of HFC circuit



## 2.4. Dispersion characteristics

The graphs below show the horizontal dispersion angle over frequency plotted using lines of equal sound pressure (isobars) at -6 dB and -12 dB. The nominal dispersion is maintained above 600 Hz, while a useful horizontal dispersion control is achieved down to 500 Hz.

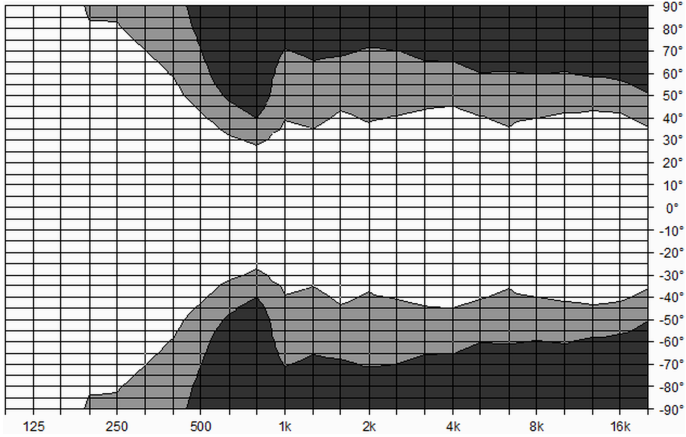

Isobar diagram Yi8 horizontal

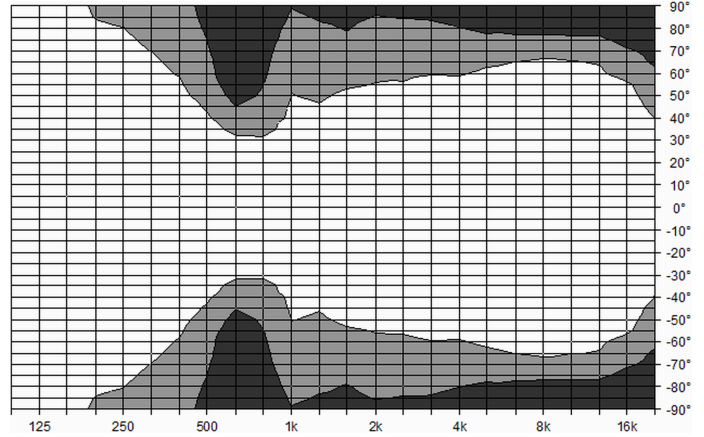

Isobar diagram Yi12 horizontal

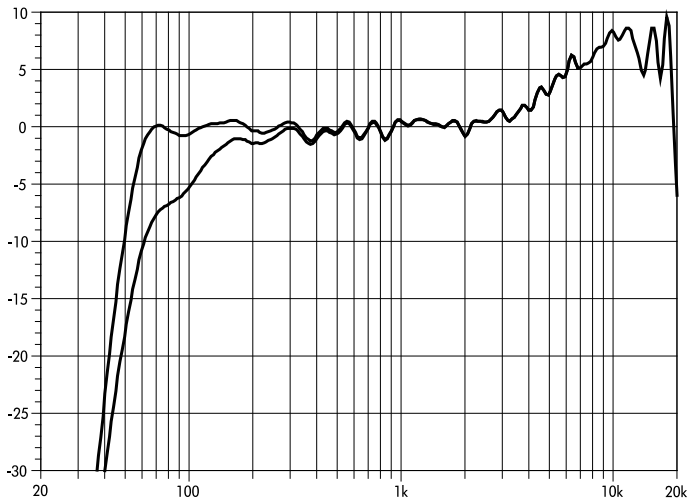

Yi8 frequency response, standard and CUT modes

## 2.5. Technical specifications

### Yi8/Yi12 system data

Frequency response (-5 dB standard) .....	54 Hz - 19 kHz
Frequency response (-5 dB CUT mode) .....	100 Hz - 19 kHz
Max. sound pressure (1 m, free field) .....	
Yi8 with D80/D12/D6 .....	139 dB/137 dB/134 dB
Yi12 with D80/D12/D6 .....	139 dB/137 dB/134 dB
.....(SPLmax peak, pink noise test signal with crest factor of 4)	

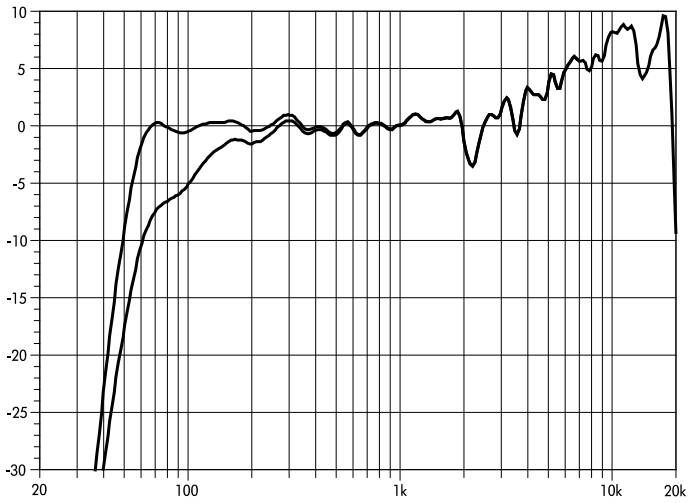

**Yi12 frequency response, standard and CUT modes**

**Yi8/Yi12 loudspeaker**

Nominal impedance.....	8 ohms
Power handling capacity (RMS/peak 10 ms) .....	400/1600 W
Nominal dispersion angle (horizontal) Yi8 .....	80°
Nominal dispersion angle (horizontal) Yi12 .....	120°
Splay angle setting .....	0° ... 14°
.....	1° increment
Components .....	2 x 8" driver
.....	1 x 1.4" exit compression driver
.....	Passive crossover network
Connections .....	2 x NL4
.....	1 x screw terminal (ST - up to 4 mm <sup>2</sup> /AWG 11)
Optional fixed cable (PG): .....	
.....	H07-RN-F, 2 x 2.5 mm <sup>2</sup> (AWG 13), 5.5 m (18 ft)
Pin assignment .....	NL4: 1+ / 1-
.....	Fixed cable (PG): Brown: (+) / Blue: (-)
Weight .....	20 kg (44 lb)

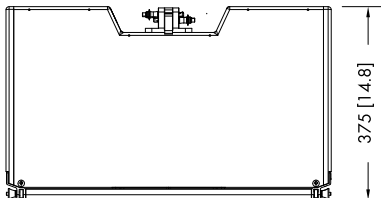
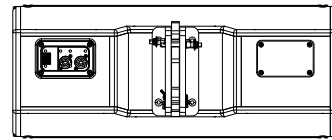
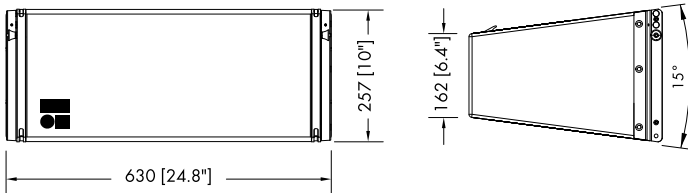

**Yi8/Yi12 cabinet dimensions in mm [inch]**



### 3.1. EU conformity of loudspeakers (CE symbol)

This declaration applies to:

**d&b Yi8 loudspeaker, Z0717**

**d&b Yi12 loudspeaker, Z0718**

manufactured by d&b audiotechnik GmbH.

All production versions of these types are included, provided they correspond to the original technical version and have not been subject to any later design or electromechanical modifications.

We herewith declare that said products are in conformity with the provisions of the respective EC directives including all applicable amendments.

A detailed declaration is available on request and can be ordered from d&b or downloaded from the d&b website at [www.dbaudio.com](http://www.dbaudio.com).

#### 3.1.1. WEEE Declaration (Disposal)

Electrical and electronic equipment must be disposed of separately from normal waste at the end of its operational lifetime.

Please dispose of this product according to the respective national regulations or contractual agreements. If there are any further questions concerning the disposal of this product, please contact d&b audiotechnik.

